



ENERPRED

INDUSTRIAL HYDRAULIC EQUIPMENT



2017



CATALOGUE

HIGH FORCE TOOLS
& EQUIPMENT



The history of “Enerpred” began with the founding of the company CJSC “Enerpred” in 1991 created to design, manufacture and repair the hydraulic equipment. A streamlined modern production, high-skilled engineering and customer service in a short time helped the company to take a leading position among the manufacturers of hydraulic equipment, and a small plant was turned into a large, financially stable and dynamic company. Today, all commercial activities related to the supply of products manufactured by CJSC “Enerpred” and to contracting with buyers, is transmitted to CJSC “TD “Enerpred”

For more than 20 years the company “Enerpred” got one of the leading roles in the hydraulic equipment and tools market in Russia and the CIS. The company’s customers are leading companies in various industries - energy, petrochemicals, machinery, metallurgy, coal and gas industries. The deliveries are made into various countries, such as Belarus, Ukraine, Kazakhstan, Uzbekistan, Azerbaijan, Armenia, Kyrgyzstan, Lithuania, Moldova, Mongolia, Turkmenistan, Ukraine, as well as in foreign countries: the UK, Japan and Israel.

The activity of the company is aimed at meeting the customer needs. “Enerpred” offers complex solutions for its customers: the selection, development, production, supply of hydraulic equipment and tools, warranty and service maintenance.

The nomenclature of the company is presented both by its own developments, the brand name “Enerpred”, and other manufacturer’s products under the brand names RiKline, PosiLock, PowerMaster, Intech.

We are proud of our customers and contribute to their development and prosperity.



TM “Enerpred” - the quality and reliability of hydraulic equipment, tools and instruments of the “Enerpred” brand are trusted by leading companies in various industries, both in Russia and abroad. All production is certified by the State Standard of Russia.

Production is carried out on the latest high-tech equipment, every product undergoes quality control at all stages of the production cycle. The quality management system established by the company is certified in accordance with ISO 9001-2008. For all the instruments and equipment of “Enerpred” there is a guarantee up to 2 years.

TM “RiKline” is a trademark of economy class presented by a wide range of hydraulic tools and equipment manufactured on the order of “TD “Enerpred” in the enterprises of China. Before selling all products and accessories are subject to rigorous quality control. Low cost hydrotool brand “Rikline” distinguishes this tool from its analogues on the market of hydraulic tools in Russia and the CIS.

TM «POSI LOCK» - is a professional tool made in the USA. It is the world's leading manufacturer of tools for dismantling planted with tension bushings, bearings, sprockets, gears and pullers. TD “Enerpred” is a representative of the company «POSI LOCK» in Russia and CIS countries. Pullers of “POSI LOCK” brand are made of high quality hardened steel, all parts are effectively protected against corrosion. Safety cage directs legs and ensures fast installation, hard grip and increased safety by preventing slipping of legs off the removable part.

TM «POWERMASTER» - is a professional bolting tools. Range of instruments of this brand is represented by torque wrenches, multipliers, impact wrenches and spring balancers.

TM “INTECH”, a trademark that combines innovative technologies of mechanical engineering with the use of mechanization aimed at the creation of technologies, design and production of new products. Most of the development investments of the company are aimed at a number of technical solutions, which allows producing unique equipment in the Russian market. One of the developments is a system of “rotor nozzles” for all types of hydraulic manipulators, from excavators to systems installed on vehicles. This product is offered to the market with the ability to transfer excavators from wheeled mover to railroad. There was designed a range of “rotors” and attachments to them. Products of TM “INTECH” either are not produced by the domestic industry or has a qualitatively new technical and operational characteristics.

Hydraulic systems, assembly diagrams.....	4	Hydraulic tilt-rotary device «INTECH».....	58
CYLINDERS AND JACKS		Attached equipment «INTECH».....	59
Single-acting general purpose jacks.....	8	Flange spreaders.....	60
Double-acting general purpose jacks.....	9	Expanding wedges.....	60
Single-acting load-lifting jacks.....	10	Trolley lifter for inspection pits.....	61
Double-acting load-lifting jacks.....	11	Main pin presser.....	61
System for power transformer winding prepressing.....	12	Track pin presser.....	61
Jacks of stage hoisting.....	12	PSC strand tensioner.....	61
Load-lifting jacks with lock nut.....	13	Oil injector.....	62
Aluminum hydraulic jacks with spring return.....	14	Installation for geophysical equipment testing.....	62
Load-lifting aluminum jacks with lock nut.....	14	Installation for stop valves testing.....	62
Aluminum hydraulic jacks with hydraulic return.....	15	EQUIPMENT FOR WORKING WITH SLING ROPES	
Medium hydraulic single-acting jacks.....	16	Sling ropes presser.....	63
Pulling jacks.....	16	Sling ropes test machines.....	64
Low pickup self-contained jacks.....	17	Splicing device.....	64
Low height jacks.....	17	RESCUE EQUIPMENT	
Low telescopic jacks.....	18	KRUG-1S, KRUG-AM.....	65
Telescopic jacks.....	18	KRUG-2M.....	66
Hydraulic telescopic aluminum jacks.....	18	KRUG-2S.....	67
Hollow rod jacks.....	19	RAILWAY TRANSPORT EQUIPMENT	
Rack jacks.....	19	Hydraulic equipment for emergency recovery operations on railway transport (HARS-30).....	68
Power cylinders.....	20	Compact hydraulic equipment for fast lifting and installation on rails of light vehicles (HARS-50).....	71
Power pulling hydraulic cylinders.....	21	Carriage for wagons transportation TTL25.....	73
Load-lifting trolley jacks.....	22	Carriage for wagons transportation.....	73
Jack accessories.....	23	Carriage fixing device.....	74
PIPE BENDERS		Load-lifting aluminum trolley jacks.....	74
Hydraulic frame-closed pipe benders.....	24	Mobile jacking installation.....	74
Self-contained frame-closed pipe benders.....	24	Equipment for rail string tensioning.....	75
Power frame-closed pipe benders.....	24	Rail lifting jacks.....	75
PULLERS		Railway leveler.....	76
Screw drive pullers with grip centering mechanism.....	25	Rail gap spreader.....	76
Screw drive pullers «POSILOCK».....	25	Reincapacityd concrete beam expander.....	77
Trolley hydraulic pullers «POSILOCK».....	26	Hydraulic sleepers expander «INTECH».....	77
Trolley hydraulic pullers.....	27	Hydromechanical torque wrench with built-in nut splitter «INTECH».....	77
Hydraulic pullers.....	28	Hydraulic rail-bender.....	77
Hydraulic pullers with grip centering drive.....	28	Wheeled jack.....	78
Pullers with integrated drive.....	29	Small gear puller.....	79
General purpose pullers.....	29	Jack for raising wheel-motor units of locomotives.....	79
Yoke pullers.....	30	Absorbing devices removal tools.....	79
Yoke pullers with integrated drive.....	30	Machines for building-up of boxes.....	80
Pressers-pullers.....	31	Cup nut loosening tool.....	80
PRESSES		Press for pressing-out of railroad engine pivot bushings.....	80
Hydraulic presses.....	32	LIFTING AND TRANSPORTING EQUIPMENT	
Jack test stand.....	32	Polypast blocks.....	81
Hydraulic presses (horizontal).....	33	Coffing hoists.....	81
Presses for shaping end bits, sleeves and clamps.....	33	Gantry crane.....	81
Table of matrices selection for shaping.....	34	PUMPS AND PUMP STATIONS	
Sheet perforating presses.....	34	Recommendations on pump selection.....	82
Perforating presses.....	35	Hydraulic foot pump.....	82
Press for mounting and dismantling of dump truck wheels KOMATSU-HD785.....	35	Hydraulic manual pumps.....	83
CUTTING TOOLS		Pump stations selection table.....	84
Hydraulic nut splitters.....	36	Pump stations with electric drive, manual unloading crane.....	85
Hydraulic cable cutters.....	36	Pump stations with electric drive, manual valve.....	85
Hydraulic general purpose cutters.....	37	Pump stations with electric drive, solenoid valve.....	86
Strand cutters.....	37	Pump stations with electric drive, solenoid valve, automatic control.....	89
Corner cutters.....	38	Mobile pump stations with electric drive.....	91
Pipes and steel sheets cutters.....	38	High-capacity pump stations with multi-hydraulic flow.....	92
Hydraulic pistol cutters.....	38	Manual valve explosion-proof motor pump stations with electric drive.....	92
BOLTING TOOLS		Pump stations with petrol drive.....	94
Hydraulic cassette torque wrenches.....	39	Pump stations with diesel drive.....	96
Hydraulic torque wrenches.....	40	Pump stations with pneumatic drive.....	97
Table of cassette/head selection.....	41	Compact pump stations.....	98
Tensor jacks.....	42	Additional options for pump stations.....	100
Torque wrenches «PowerMaster».....	43	Hydraulic systems accessories.....	102
Multipliers «PowerMaster».....	44	High pressure hoses.....	107
Straight impact wrenches «PowerMaster».....	45	TOOLS AND EQUIPMENT OF «RIKLINE»	
Angled impact wrenches «PowerMaster».....	46	Single-acting load-lifting cylinders.....	110
Open-ended impact wrenches «PowerMaster».....	46	Self-contained cylinders.....	110
SPECIAL EQUIPMENT AND TOOLS		Hydraulic pullers with built-in pump.....	111
Spring balancers «PowerMaster».....	47	Hydraulic frame-closed pipe benders.....	111
Hydraulic systems for moving heavy equipment on rails.....	48	Hydraulic crimping presses.....	112
Set of equipment for lifting mining excavators KOP4-100.....	49	Wire rope pulling hoist.....	112
Set of equipment for lifting mine dump trucks - KOP1-50.....	50	Hydraulic pallet truck.....	113
Set of equipment for lifting mine dump trucks during the assembly work at the assembly site KOP2-50.....	50	Scissor lift table.....	113
Hydraulic systems for trenchless pipe-laying – UG600T.....	51	Hydraulic folding cranes.....	114
Hydraulic systems for trenchless pipe-laying - UG100T.....	52	Hydraulic stackers.....	114
Hydraulic framed modular systems for ground cutoff (UGRM).....	53	Lifters.....	115
Mobile and stationary complexes for liquid pumping-off and emergency operations.....	53	Portable accumulator tools.....	116
Hydraulic stations for road-building tools.....	55	Pump stations with electric drive.....	117
Multifunctional pumping unit.....	56		
Connecting rod pin pullers.....	57		
Motor pulley pullers.....	57		
Crank spreading tools.....	57		

A set including a pump and single acting tool.

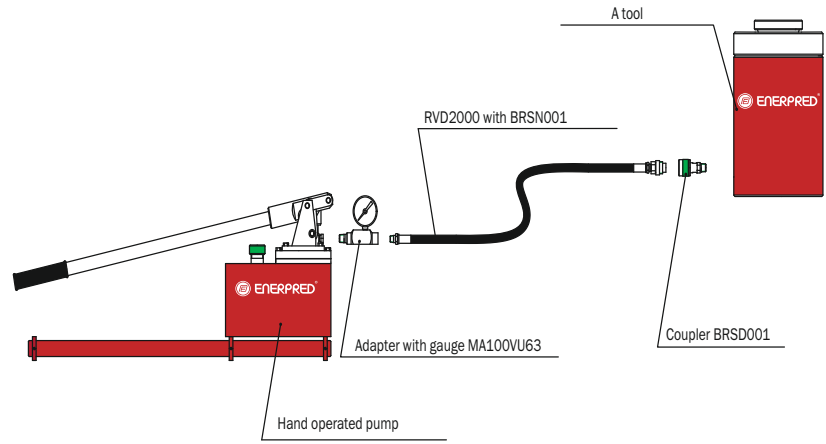

A set including a pump, single acting tool, and safety valve.

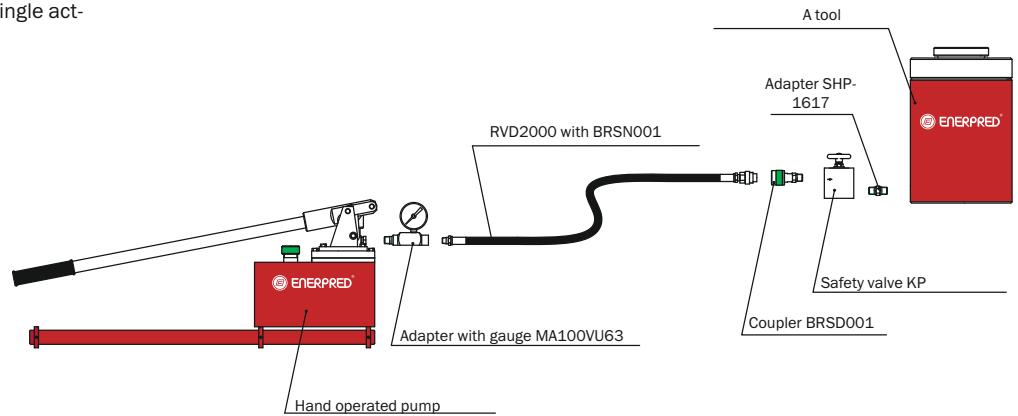

A set including a pump, single acting tool, and hydrolock used with hand operated pump.

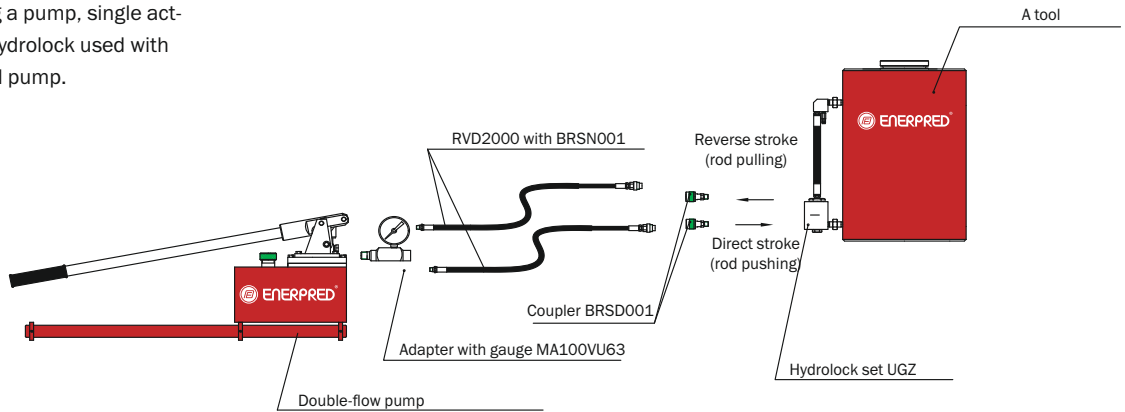

System with one working mechanism of two-way action working from a pump station with an electric-petrol drive

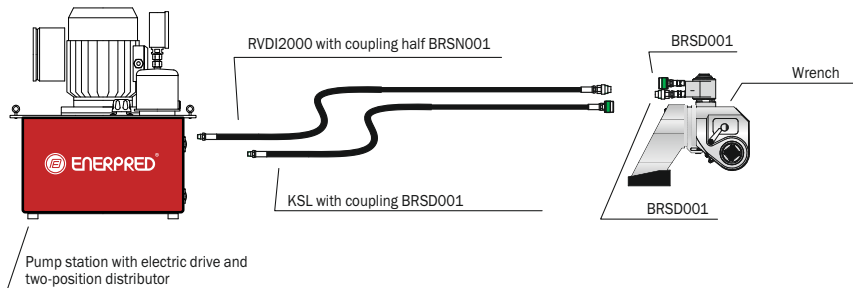

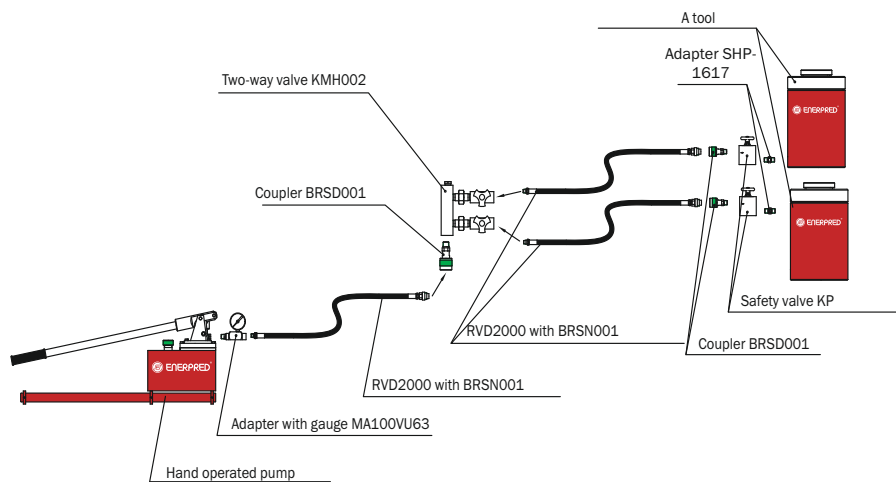

A set including a pump, double acting tools, and safety valve

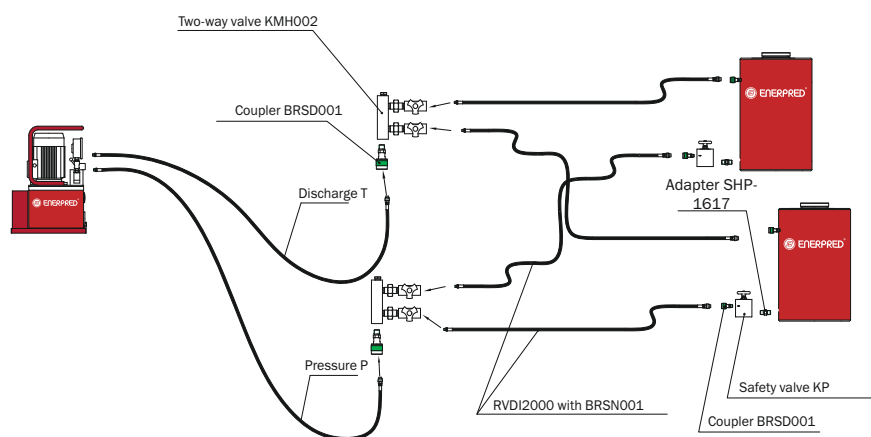

A set including a pump, two double acting tools, and safety valve used with electric gasoline and air power pack

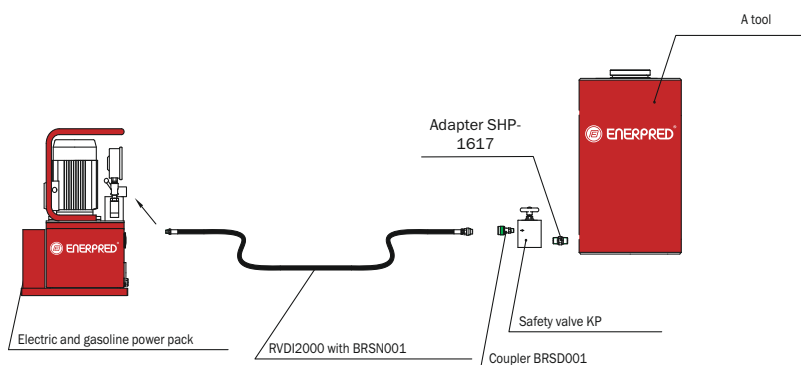

A set including a pump single acting, and safety valve used with electric gasoline and air power pack

Conventions:

	A tool (cylinder, puller, pipe bender...)		Coupler
	Electric and gasoline power pack		Gauge
	Hand operated pump		Two-way valve
	High pressure hose		Safety valve

Cylinders

Equipment for lifting and moving is one of the top and the largest groups in the nomenclature of CJSC "TD "Enerpred ", it is presented by general purpose, load, pulling, wedge, low, etc. cylinders and cylinders, both with a spring or hydraulic return.

Cylinder is a special device, which is a portable lifting device designed for lifting, moving and fixing various heavy objects at a given height. In the product line of the company "Enerpred" there are cylinders for the work and operations of different levels of complexity, from lifting and replacing of small objects to positioning and fixing of large objects for a long time, tightening hull of vessels, balancing bridge openings, pushing the pipe through soil, complicated construction works etc.

Cylinders can be used alone or as part of other equipment and tools. Cylinder is the main power element of the most hydraulic tools and equipment. Experts of the company focus on quality and reliability of cylinders, continuous improvement of the product operational characteristics.

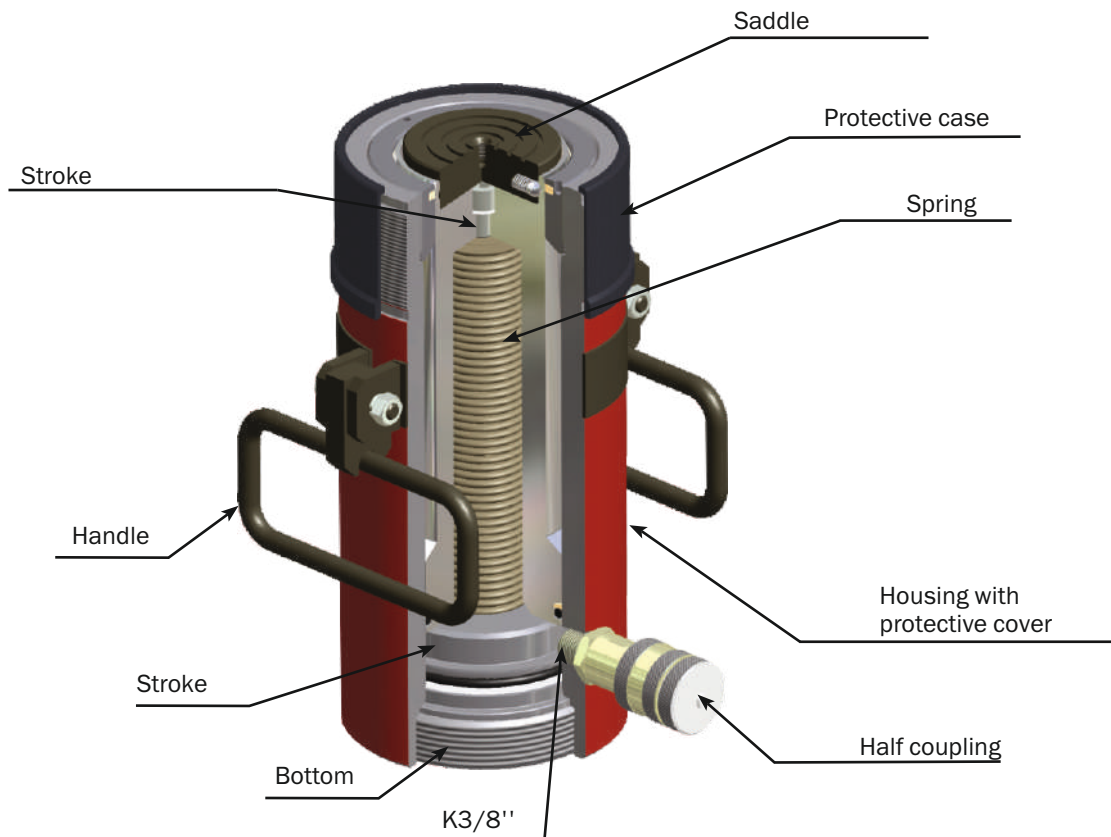

Housing

In the manufacture of cylinders both one-piece constructions and constructions to be screwed down are used. Cylinders with all-metal housing are machined from steel cylindrical forging of stainless steel followed by heat treatment. Cylinders from solid strokes can reduce the number of connections and seals, and thus enhance the functional reliability. In the manufacture of long cylinders the pipe that has a high quality and honed inner surface is used as housing.

"Enerpred" colors its products with powder coatings, followed by polymerization in a high temperature furnace, which ensures impressive appearance of the instrument and protects it from corrosion. Powder coating is not chipped.

In the manufacture of cylinder bore area of the trademark "Enerpred" a number of finishing operations are produced for high-end roughness that allows a seal to work for a longer time. Oxycarbonitration provides high hardness of both external and internal surfaces.

Seals

Seals must ensure leak tightness under high pressure and load limits, while not hindering the stroke retraction, abrasion resistance and heat resistance, especially in the continental climate of Russia. "Enerpred" uses high-strength combined seals of composite materials (carbon-filled fluoroplastic) that meet the above requirements, increase service life by an average of 40-50%, up to 15,000 cycles. For operation at high temperatures, seals of heat-resistant rubber are made on the product.

Spring

The quality of the spring determines the performance of the cylinder, as rapid retraction of the stroke to the starting position is very important in the operation process. Resource and spring power are characterized by the number of turns, fitting in the cylinder volume, cross-section and the material from which it is made. "Enerpred" uses springs with rectangular section, custom-made and designed for 10,000 cycles. Such design allows putting more turns, which reduces the size of the cylinder and using the combined spring system (spring-in-spring), which increases the speed and force of the stroke retraction.

Pressure

High pressure ensures better volume and weight characteristics, but the ultra-high pressure requires incredibly high resisting characteristics of materials. "Enerpred" uses a formula of 700-800 Bar, which is the standard for international peers.

Compatibility

Compatibility is possible at the same working pressure and match of thread under the coupling, which allows the consumer to complete systems of tools from different vendors. "Enerpred" manufactures tools fully compatible with the world's leading tools manufacturers with screw thread of all connections K3/8".

Oxycarbonitration

Liquid oxycarbonitration is a kind of chemical and thermal processing, which provides:

- Increase of the surface hardness by 2-5 times;
- Increase of the wear resistance by 2-10 times;
- Increase of the fatigue limit by 30-80%;
- Increase of the corrosion resistance by 50-200 times;
- Reduction of the friction factor by 1.5-2 times;
- Exclusion of scoring and tongs in friction pairs.

Special hydraulic cylinders

The company "Enerpred" receives the orders for special hydraulic cylinders production, used as hydraulic power components of industrial machinery and equipment.

In the manufacture of cylinder bore area of "Enerpred" brand, a number of finishing operations are produced for high-end roughness that allows a seal to work for longer time. In composite constructions the pipe that has a high quality and honed inner surface is used.

Irrespective of construction, all cylinders have high resistance and reliability.

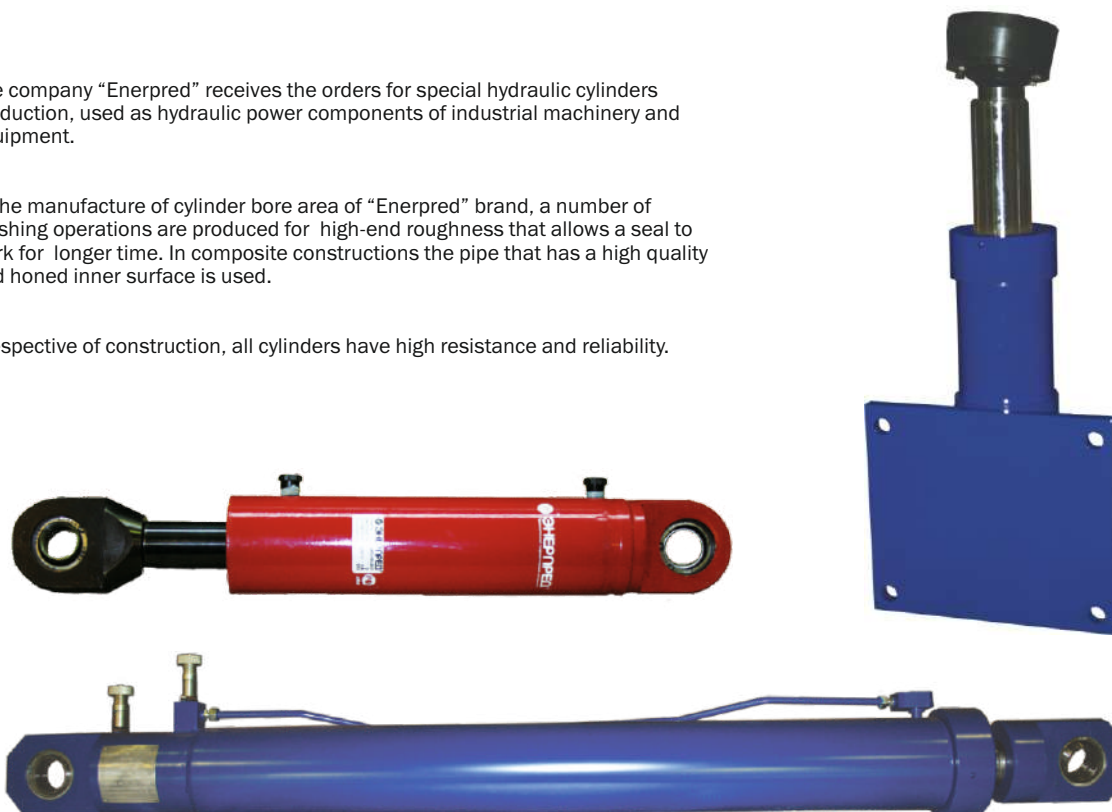

Single-acting general purpose cylinders

Series DU...P...
 Load capacity — 5-200 ton
 Pressure — 700 Bar
 Spring stroke retraction

- Designed for lifting and moving weights, complex constructions and repairs;
- Threaded holes on the bottom and thread on the housing provide wide use as load-bearing elements in the presses, benders, pullers, etc.;
- Wear-resistant housing coating, applied by powder technique, protects against corrosion and external influences;
- Powerful spring for quick stroke retraction;
- Ability to work in any position.



Models: DU20P50, DU35P50, DU100P50, DU100P150

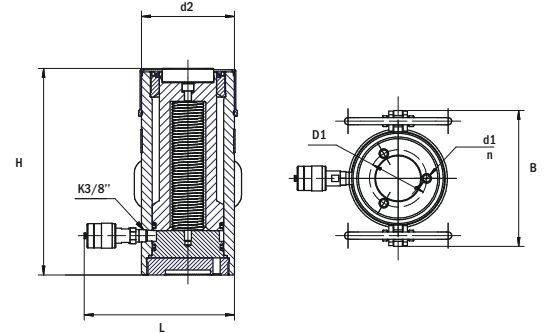

Cylinders with the capacity over 50 ton are recommended to be equipped with the safety valve.
 Cylinders with the capacity over 50 ton are recommended to be equipped with float supports.

Models	Capacity, ton	Stroke, mm	Oil working capacity, cm ³	Mounting			Exterior thread d2, mm	Dimensions (BxLxH), mm	Weight, kg	Saddle
				d1, mm	n, pcs	D1, mm				
DU5P50	5,6	50	40	—	—	—	M42x1,5	42x122x126	1,4	PD5
DU5P100		100	80	—	—	—	M42x1,5	42x122x176	1,7	PD5
DU5P150		150	106	—	—	—	M40x1,5	40x120x258	2,2	PD5
DU5P200		200	142	—	—	—	M40x1,5	40x120x308	2,6	PD5
DU10P50	11,3	50	80	M8	2	42	M60x2	60x140x136	2	PD10
DU10P100		100	160	M8	2	42	M60x2	60x140x186	3,6	PD10
DU10P150		150	240	M8	2	42	M60x2	60x140x236	4,4	PD10
DU10P200		200	318	M8	2	42	M60x2	60x140x314	5,8	PD10
DU10P300	300	477	M8	2	42	M60x2	60x140x414	7,5	PD10	
DU15P150	14,1	150	295	M8	2	42	M60x2	70x150x272	7	PD10
DU15P250		250	490	M10	2	38	M70x2	70x150x364	9,2	PD15
DU15P500		500	982	M10	2	38	M70x2	70x150x649	16	PD15
DU20P50		22,2	50	156	M10	2	45	M82x2	83x163x198	7,4
DU20P100	100		312	M10	2	45	M82x2	83x163x248	9	PD35
DU20P150	150		468	M10	2	45	M82x2	83x163x298	11	PD35
DU20P200	200		623	M10	2	45	M82x2	83x163x348	12	PD35
DU20P250	250		779	—	—	—	M82x2	95x174x359	13,1	PD35
DU20P300	300		935	M10	2	45	M82x2	83x163x448	15	PD35
DU20P360	360		1122	M10	2	45	M82x2	83x163x508	17	PD35
DU35P50	35,8		50	252	M12	2	50	M105x2	110x190x198	12
DU35P100		100	503	M12	2	50	M105x2	170x210x248	16	PD35
DU35P150		150	754	M12	2	50	M105x2	170x190x296	18,1	PD35
DU35P200		200	1005	M12	2	50	M105x2	170x190x348	21,3	PD35
DU35P250		250	1256	M12	2	50	M105x2	170x190x398	24	PD35
DU35P300	300	1508	M12	2	50	M105x2	170x190x448	27	PD35	
DU50P50	56	50	392	M12	3	80	M130x2	130x210x189	17	PD100
DU50P100		100	785	M12	3	80	M130x2	190x220x245	22,6	PD100
DU50P150		150	1177	M12	3	80	M130x2	190x220x289	26	PD100
DU50P200		200	1570	M12	3	80	M130x2	190x220x339	29,2	PD100
DU50P250		250	1964	M12	3	80	M130x2	190x220x389	31	PD100
DU50P300	300	2356	M12	3	80	M130x2	190x220x439	37	PD100	
DU100P50	109,8	50	770	M16	4	110	M175x3	240x261x228	40,6	PD100
DU100P100		100	1540	M16	4	110	M175x3	240x261x278	47,3	PD100
DU100P150		150	2309	M16	4	110	M175x3	240x261x328	53,9	PD100
DU100P200		200	3079	M16	4	110	M175x3	240x261x385	63,7	PD100
DU100P250		250	3848	M16	4	110	M175x3	240x261x435	70,7	PD100
DU100P300		300	4618	M16	4	110	M175x3	240x261x485	77,7	PD100
DU150P50	162	50	1135	M12	3	110	M210x3	270x289x183	45	PD200
DU150P100		100	2270	M12	3	110	M210x3	270x289x233	53,5	PD200
DU150P150		150	3405	M12	3	110	M210x3	270x289x305	73	PD200
DU150P200		200	4540	M12	3	110	M210x3	270x289x355	83	PD200
DU150P250		250	5675	M12	3	110	M210x3	270x289x405	85	PD200
DU150P300	300	6809	M12	3	110	M210x3	270x289x455	98	PD200	
DU200P50	202	50	1570	M16	4	160	M240x3	323x325x283	95	PD200
DU200P100		100	3142	M16	4	160	M240x3	323x325x333	108	PD200
DU200P150		150	4712	M16	4	160	M240x3	323x325x383	121	PD200
DU200P200		200	6283	M16	4	160	M240x3	323x325x433	134	PD200
DU200P250		250	7854	M16	4	160	M240x3	323x325x483	147	PD200
DU200P300		300	9425	M16	4	160	M240x3	323x325x533	160	PD200

Double-acting general purpose cylinders

Series DU...G...
Load capacity — 10-200 ton
Pressure — 700 Bar
Hydraulic stroke retraction

- Effective in horizontal movement of objects, the hydraulic stroke retraction ensures quick preparation of the cylinder for the next cycle;
- Wear-resistant housing coating, applied by powder technique to protect against corrosion and external influences;
- Ability to work in any position
- Threaded holes on the bottom and thread on the housing provide wide use as load-bearing elements in the equipment performing cyclic operation.
- Models of these series are equipped with a safety valve which protects cylinder end from overload.





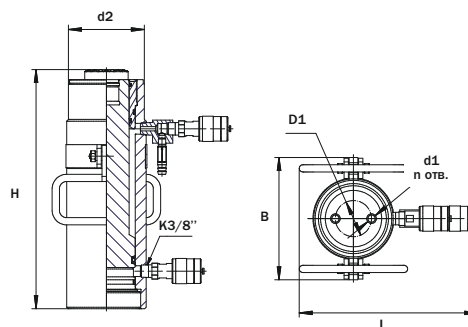

Models: DU50G150, DU100G150



Models	Capacity, ton	Stroke, mm	Oil working capacity, cm ³	Mounting			Exterior thread d2, mm	Dimensions (BxLxH), mm	Weight, kg	Saddle
				d1, MM	n, шт	D1, MM				
DU10G100	11,3	100	80	M8	2	42	M60x2	60x144x285	5,9	PD5
DU10G150		150	120	M8	2	42	M60x2	60x144x335	6,7	PD5
DU10G200		200	160	M8	2	42	M60x2	60x144x385	7,6	PD5
DU10G250		250	200	M8	2	42	M60x2	60x144x435	8,3	PD5
DU20G100	22,2	100	151	M10	2	45	M82x2	83x200x276	11	PD20
DU20G150		150	294	M10	2	45	M82x2	83x200x326	12,6	PD 20
DU20G200		200	393	M10	2	45	M82x2	83x200x376	14,3	PD 20
DU20G250		250	379	M10	2	45	M82x2	83x200x426	16	PD 20
DU20G300		300	456	M10	2	45	M82x2	83x200x476	17,6	PD 20
DU20G500		500	980	M10	2	45	M82x2	83x200x676	24,3	PD 20
DU50G100	56	100	503	M12	3	80	M130x2	190x257x263	25,8	PD 100
DU50G150		150	754	M12	3	80	M130x2	190x257x313	30,4	PD 100
DU50G200		200	1005	M12	3	80	M130x2	190x257x363	34,6	PD 100
DU50G250		250	1256	M12	3	80	M130x2	190x257x413	38,8	PD 100
DU50G300		300	1508	M12	3	80	M130x2	190x257x463	43	PD 100
DU50G500		500	2513	M12	3	80	M130x2	190x257x663	59	PD 100
DU100G100	109,8	100	1540	M16	4	110	M175x3	240x298x307	55,4	PD 100
DU100G150		150	2309	M16	4	110	M175x3	240x298x357	63,1	PD 100
DU100G200		200	3079	M16	4	110	M175x3	240x298x407	70,8	PD 100
DU100G250		250	3848	M16	4	110	M175x3	240x298x457	78,4	PD 100
DU100G300		300	4618	M16	4	110	M175x3	240x298x507	86,1	PD 100
DU100G400		400	6158	M16	4	110	M175x3	240x298x607	102	PD 100
DU100G500	500	7697	M16	4	110	M175x3	240x298x705	117	PD 100	
DU150G100	162	100	1767	M12	3	110	M210x3	270x328x260	67	PD200
DU150G150		150	2651	M12	3	110	M218x3	270x328x310	78	PD200
DU150G200		200	3535	M12	3	110	M210x3	270x326x360	90	PD 200
DU150G250		250	4418	M12	3	110	M218x3	270x328x410	102	PD200
DU150G300		300	5302	M12	3	110	M210x3	270x328x460	113	PD200
DU150G500		500	8836	M12	3	110	M218x3	270x328x710	165	PD200
DU200G100*	202	100	2011	M16	4	160	M242x3	323x362x335	112	PD 200
DU200G150*		150	3016	M16	4	160	M242x3	323x362x385	126	PD 200
DU200G200*		200	4021	M16	4	160	M242x3	323x362x435	140	PD 200
DU200G250*		250	5026	M16	4	160	M242x3	323x362x485	154	PD 200
DU200G300		300	6032	M16	4	160	M242x3	323x362x535	168	PD 200
DU200G500		500	10053	M16	4	160	M242x3	351x390x764	282	PD 200

* Pressure 630 Bar

	Pumps selection table p.82		Cylinders accessories p.23
	Hydraulic accessories p.102		Hydraulic systems. Set-up schemes p.4

Single-acting load-lifting cylinders

Series DG...P...

Load capacity — 10-400 ton

Pressure — 700/800 Bar

Spring stroke retraction



Models: DG10P200, DG100P100

- Designed for lifting and handling weights during assembly, dismantling and repair works;
- High-impact support of hardened steel, set on the stroke, protects it from damage;
- Ribbed surface of the support prevents weight from sliding;
- Wear-resistant housing coating, applied by powder technique to protect against corrosion and external influences;
- Powerful spring for quick stroke retraction;
- Ability to work in any position;
- Cylinders with the capacity over 300 tons are equipped with tilt saddles.

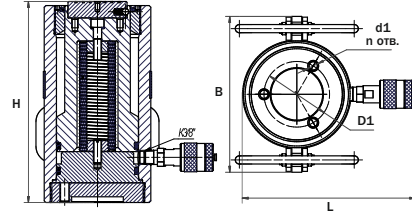

Aluminium load-lifting cylinders p. 14

Load-lifting cylinders of "RiKline" p. 110

Models	Capacity, ton	Stroke, mm	Oil working capacity, cm ³	Mounting			Dimensions (BxLxH), mm	Weight, kg	Saddle
				d1, mm	n, pcs	D1, mm			
DG5P200	5	200	142	M8	2	42	40x120x308	2,6	Pd10
DG10P50		50	80	M8	2	42	60x140x136	2,8	PD10
DG10P100	11,3	100	160	M8	2	42	60x140x186	3,6	PD10
DG10P150		150	240	M8	2	42	60x140x236	4,4	PD10
DG10P200	22,2	200	318	M8	2	35	60x139x297	5,7	PD10
DG20P50		50	156	M10	2	45	83x163x198	7,4	PD35
DG20P100	35,8	100	312	M10	2	45	83x163x248	9	PD35
DG20P150		150	466	M10	2	45	83x163x298	10,6	PD35
DG20P200	50	200	624	M10	2	45	83x163x348	12	PD35
DG20P250		250	779	M10	2	45	83x163x398	13,7	PD35
DG20P300	109,8	300	935	M10	2	45	83x163x448	15,3	PD35
DG20P360		360	1122	M10	2	45	83x163x508	17,2	PD35
DG35P50	162	50	252	M12	2	50	110x190x198	12	PD35
DG35P100		100	503	M12	2	50	170x210x248	16	PD35
DG35P150	202	150	754	M12	2	50	170x210x298	19	PD35
DG35P200		200	1005	M12	2	50	170x210x348	21,5	PD35
DG35P250	297	250	1257	M12	2	50	170x210x398	24	PD35
DG35P300		300	1508	M12	2	50	170x210x448	27	PD35
DG50P50	400	50	392	M10	2	80	190x220x189	17	stroke saddle
DG50P100		100	785	M12	3	80	190x220x245	22,4	PD100
DG50P150	505	150	1177	M12	3	80	190x220x289	25	PD100
DG50P200		200	1570	M12	3	80	190x220x340	29,7	PD100
DG50P250	610	250	1964	M12	3	80	190x220x389	33,4	PD100
DG50P300		300	2356	M12	3	80	190x220x439	37	PD100
DG100P50	109,8	50	770	M16	4	110	240x261x228	40,3	PD100
DG100P100		100	1540	M16	4	110	240x261x278	47,1	PD100
DG100P150	162	150	2309	M16	4	110	240x261x328	53,7	PD100
DG100P200		200	3079	M16	4	110	240x261x385	63,6	PD100
DG100P250	202	250	3848	M16	4	110	240x261x435	70,2	PD100
DG100P300		300	4618	M16	4	110	240x261x485	77	PD100
DG150P50	297	50	1135	M12	3	110	270x289x183	45	PD200
DG150P100		100	2270	M12	3	110	270x289x233	53,5	PD200
DG150P150	400	150	3405	M12	3	110	270x291x355	63,2	PD200
DG150P200		200	4540	M12	3	110	270x291x355	83	PD200
DG150P250	505	250	5675	M12	3	110	270x291x383	82,3	PD200
DG150P300		300	6809	M12	3	110	270x291x455	98	PD200
DG200P50	610	50	1570	M16	4	160	323x325x283	96	PD200
DG200P100		100	3142	M16	4	160	323x325x333	109	PD200
DG200P150	202	150	4712	M16	4	160	323x325x383	122	PD200
DG200P200		200	6283	M16	4	160	323x325x433	135	PD200
DG200P250	297	250	7854	M16	4	160	323x325x483	148	PD200
DG200P300		300	9425	M16	4	160	323x325x533	161	PD200
DG300P50	400	50	2076	—	—	—	366x370x294	127	PDD400
DG300P100		100	4153	—	—	—	366x370x344	145	PDD400
DG300P150	505	150	6229	—	—	—	366x370x394	164	PDD400
DG300P200		200	8305	M16	2	120	366x370x444	182	PDD400
DG300P250	610	250	10382	—	—	—	366x370x494	200	PDD400
DG300P300		300	12458	—	—	—	366x370x544	219	PDD400
DG400P50	202	50	2863	—	—	—	408x410x330	190	PDD400
DG400P100		100	5726	—	—	—	408x410x380	211	PDD400
DG400P150	297	150	8589	—	—	—	408x410x430	233	PDD400
DG400P200		200	11451	—	—	—	408x410x480	256	PDD400
DG400P250	400	250	14314	—	—	—	408x410x530	280	PDD400
DG400P300		300	17177	—	—	—	408x410x580	300	PDD400
DG500P50	505	50	3535	—	—	—	439x440x340	232	PDD400
DG500P100		100	7069	—	—	—	439x440x390	260	PDD400
DG500P150	610	150	10603	—	—	—	439x440x440	286	PDD400
DG500P200		200	14138	—	—	—	439x440x490	314	PDD400
DG500P250	202	250	17672	—	—	—	439x440x540	340	PDD400
DG500P300		300	21206	—	—	—	439x440x590	368	PDD400
DG600P50	297	50	4277	—	—	—	478x480x340	290	PDD400
DG600P100		100	8553	—	—	—	478x480x390	326	PDD400
DG600P150	400	150	12830	—	—	—	478x480x440	362	PDD400
DG600P200		200	17106	—	—	—	478x480x490	399	PDD400
DG600P250	505	250	21383	—	—	—	478x480x540	435	PDD400
DG600P300		300	25659	—	—	—	478x480x590	472	PDD400

Double-acting load-lifting cylinders

Series DG...G...
Capacity – 50-600 ton
Pressure – 700/800 Bar



Models: DG10P200, DG100P100

- Due to reliable design and high capacity they are ideal for responsible works;
- High-impact saddle of hardened steel, set on the stroke, protects it from damage;
- Ribbed surface of the saddle prevents weight from sliding;
- Wear-resistant housing coating, applied by powder technique to protect against corrosion and external influences;
- Hydraulic stroke retraction ensures quick preparation of the cylinder for the next cycle;
- Ability to work in any position;
- Cylinders with the capacity over 300 tons are equipped with tilt saddles.

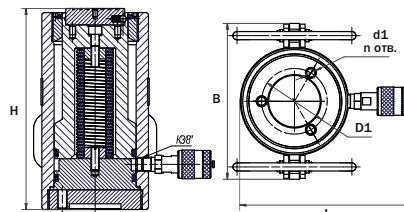

Models	Capacity, ton	Stroke, mm	Oil working capacity, cm ³	Mounting			Dimensions (BxLxH), mm	Weight, kg	Saddle
				d1, mm	n, pcs	D1, mm			
DG5P200	5	200	142	M8	2	42	40x120x308	2,6	PD10
DG10P50		50	80	M8	2	42	60x140x136	2,8	PD10
DG10P100	11,3	100	160	M8	2	42	60x140x186	3,6	PD10
DG10P150		150	240	M8	2	42	60x140x236	4,4	PD10
DG10P200	22,2	200	318	M8	2	35	60x139x297	5,7	PD10
DG20P50		50	156	M10	2	45	83x163x198	7,4	PD35
DG20P100		100	312	M10	2	45	83x163x248	9	PD35
DG20P150		150	466	M10	2	45	83x163x298	10,6	PD35
DG20P200		200	624	M10	2	45	83x163x348	12	PD35
DG20P250		250	779	M10	2	45	83x163x398	13,7	PD35
DG20P300	35,8	300	935	M10	2	45	83x163x448	15,3	PD35
DG20P360		360	1122	M10	2	45	83x163x508	17,2	PD35
DG35P50		50	252	M12	2	50	110x190x198	12	PD35
DG35P100		100	503	M12	2	50	170x210x248	16	PD35
DG35P150		150	754	M12	2	50	170x210x298	19	PD35
DG35P200		200	1005	M12	2	50	170x210x348	21,5	PD35
DG35P250	50	250	1257	M12	2	50	170x210x398	24	PD35
DG35P300		300	1508	M12	2	50	170x210x448	27	PD35
DG50P50		50	392	M10	2	80	190x220x189	17	stroke saddle
DG50P100		100	785	M12	3	80	190x220x245	22,4	PD100
DG50P150		150	1177	M12	3	80	190x220x289	25	PD100
DG50P200		200	1570	M12	3	80	190x220x340	29,7	PD100
DG50P250	109,8	250	1964	M12	3	80	190x220x389	33,4	PD100
DG50P300		300	2356	M12	3	80	190x220x439	37	PD100
DG100P50		50	770	M16	4	110	240x261x228	40,3	PD100
DG100P100		100	1540	M16	4	110	240x261x278	47,1	PD100
DG100P150		150	2309	M16	4	110	240x261x328	53,7	PD100
DG100P200		200	3079	M16	4	110	240x261x385	63,6	PD100
DG100P250	162	250	3848	M16	4	110	240x261x435	70,2	PD100
DG100P300		300	4618	M16	4	110	240x261x485	77	PD100
DG150P50		50	1135	M12	3	110	270x289x183	45	PD200
DG150P100		100	2270	M12	3	110	270x289x233	53,5	PD200
DG150P150		150	3405	M12	3	110	270x291x355	63,2	PD200
DG150P200		200	4540	M12	3	110	270x291x355	83	PD200
DG150P250	202	250	5675	M12	3	110	270x291x383	82,3	PD200
DG150P300		300	6809	M12	3	110	270x291x455	98	PD200
DG200P50		50	1570	M16	4	160	323x325x283	96	PD200
DG200P100		100	3142	M16	4	160	323x325x333	109	PD200
DG200P150		150	4712	M16	4	160	323x325x383	122	PD200
DG200P200		200	6283	M16	4	160	323x325x433	135	PD200
DG200P250	297	250	7854	M16	4	160	323x325x483	148	PD200
DG200P300		300	9425	M16	4	160	323x325x533	161	PD200
DG300P50		50	2076	—	—	—	366x370x294	127	PPD400
DG300P100		100	4153	—	—	—	366x370x344	145	PPD400
DG300P150		150	6229	—	—	—	366x370x394	164	PPD400
DG300P200		200	8305	M16	2	120	366x370x444	182	PPD400
DG300P250	400	250	10382	—	—	—	366x370x494	200	PPD400
DG300P300		300	12458	—	—	—	366x370x544	219	PPD400
DG400P50		50	2863	—	—	—	408x410x330	190	PPD400
DG400P100		100	5726	—	—	—	408x410x380	211	PPD400
DG400P150		150	8589	—	—	—	408x410x430	233	PPD400
DG400P200		200	11451	—	—	—	408x410x480	256	PPD400
DG400P250	505	250	14314	—	—	—	408x410x530	280	PPD400
DG400P300		300	17177	—	—	—	408x410x580	300	PPD400
DG500P50		50	3535	—	—	—	439x440x340	232	PPD400
DG500P100		100	7069	—	—	—	439x440x390	260	PPD400
DG500P150		150	10603	—	—	—	439x440x440	286	PPD400
DG500P200		200	14138	—	—	—	439x440x490	314	PPD400
DG500P250	610	250	17672	—	—	—	439x440x540	340	PPD400
DG500P300		300	21206	—	—	—	439x440x590	368	PPD400
DG600P50		50	4277	—	—	—	478x480x340	290	PPD400
DG600P100		100	8553	—	—	—	478x480x390	326	PPD400
DG600P150		150	12830	—	—	—	478x480x440	362	PPD400
DG600P200		200	17106	—	—	—	478x480x490	399	PPD400
DG600P250	610	250	21383	—	—	—	478x480x540	435	PPD400
DG600P300		300	25659	—	—	—	478x480x590	472	PPD400

System for power transformer winding prepressing



The system is intended for preliminary pressing of power transformer winding during repair work. The system complies with the requirements and instructions for repair of transformers.

- The system includes:
- cylinder DG 50P40S - 4 pcs.
 - hose RVD2000 - 1 pc.
 - hoses RVD4000 - 4 pcs.
 - pump NRG-7035 - 1 pc.
 - multiport plug valve KMH4 - 1 pc.
 - coupler BRSD001 - 1 pc.
 - gauge MA100VU63 - 1 pc.

Model	Capacity, ton	Stroke, mm	Oil working capacity, cm ³	Mounting			Dimensions (BxLxH), mm	Weight, kg	Saddle
				d1, mm	n, pcs	D1, mm			
DG50P40S	56	40	315	M10	2	80	130x209x108	9,9	PD100

Cylinders of stage hoisting

Series DS...P...
Capacity — 100-200 ton
Pressure — 700 Bar
Spring stroke retraction

The unique system allows to raise weight to the height and fix it in the up position for a long time;



Models: stands, cylinder DG200P150, holders

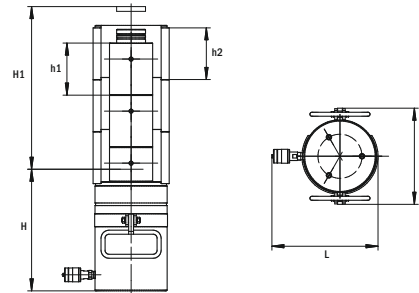

Model	Capacity, ton	Height H1, min, mm	Lift Height H1, mm	Height H max, mm	Number of holders and stands	Height h2, mm/ weight of holders, kg	Height h1, mm/ weight of stands, kg	Dimensions (BxLxH), mm	Weight, kg	Cylinder used	Saddle
DS50G500	56	313	516	829	3 & 3	135/5,8	111/3,9; 135/4,8 -2pcs	190x256x313	61,63	DG50G150	PPD100
DS100P515	109,8	298	505	803	3 и 3	135/7	91/6,1-1pcs; 135/9,2-2pcs	240x260x298	92	DG100P150	PPD100
DS200P510	202	369	510	879	7 и 6	65/5,9	95/17-1pcs; 65/12-4pcs; 55/6,9-1pcs	320x322x369	220	DG200P150	PPD200



Stage hoisting system operation sequence

Operation concept

1. Lift the weight by length of stroke action and set the holder on the cylinder housing;
2. Gently release the pressure, lower the weight on the holder;
3. Set the stand on the stroke, repeat the lift;
4. Set the second holder on the first one, etc.

Lock-nut load-lifting cylinders

Series DG...P...G
Capacity — 50-500 ton
Pressure — 700/800 Bar
Spring stroke retraction



Models: DG100P150G, DG50P200G

- You can combine the power of hydraulic lifting with a secure mechanical system of weight support;
- Safety nut allows you to fix the weight in the up position for a long time, ensuring a safe operation with the raised weight;
- High-impact saddle of hardened steel, set on the stroke, protects it from damage;
- Ribbed surface of the saddle prevents weight from sliding;
- Wear-resistant housing coating, applied by powder technique, protects against corrosion and external influences;
- Cylinders with the capacity over 200 ton are equipped with tilt saddles.

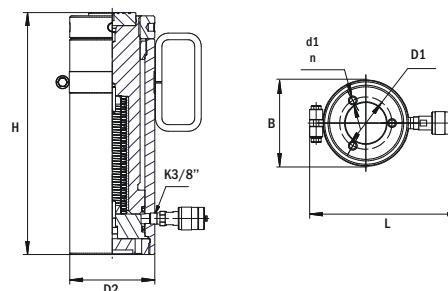

Aluminium load-lifting cylinders p.14 At half the weight with the same load capacity

Model	Capacity, ton	Stroke, mm	Oil working capacity, cm ³	Mounting			D2, mm	Dimensions (BxLxH), mm	Weight, kg	Saddle
				d1, mm	n, pcs	D1, mm				
DG35P150G	35,8	150	754	M12	3	80	110	170x190x327	20,8	PD100
DG35P200G		200	1005	M12	3	80	110	170x190x377	23,2	PD100
DG50P100G	56	100	785	M12	3	80	130	190x220x270	25,6	PD100
DG50P150G		150	1177	M12	3	80	130	190x210x320	29,4	PD100
DG50P200G		200	1570	M12	3	80	130	130x231x370	33	PD100
DG50P250G		250	1964	M12	3	80	130	190x220x420	37,2	PD100
DG50P300G		300	2356	M12	3	80	130	190x220x487	42	PD100
DG50P500G		500	3930	M12	3	80	130	190x220x707	56	PD100
DG100P50G	109,8	50	770	M16	3	110	170	240x260x280	50,6	PD100
DG100P100G		100	1540	M16	3	110	170	240x260x330	58,3	PD100
DG100P150G		150	2409	M16	4	110	170	240x260x380	66,6	PD100
DG100P200G		200	3079	M16	4	110	170	240x260x435	75,3	PD100
DG100P250G		250	3848	M16	4	110	170	240x260x485	82,9	PD100
DG100P300G		300	4618	M16	4	110	170	240x260x535	90,6	PD100
DG150P150G	162	150	3405	M12	3	110	210	293x290x375	90,3	PD200
DG150P200G		200	4540	M12	3	110	210	270x289x440	99	PD150
DG150P250G		250	5672	M12	3	110	210	270x289x490	109	PD150
DG150P300G		300	6809	M12	3	110	210	270x289x540	120	PD150
DG200P50G*		50	1570	M16	4	160	245	323x325x332	110	PPD200
DG200P100G*		100	3142	M16	4	160	245	323x325x382	125	PPD200
DG200P150G	202	150	4712	M16	4	160	245	323x325x432	140	PPD200
DG200P200G		200	6283	M16	4	160	245	323x325x482	155	PPD200
DG200P250G		250	7854	M16	4	160	245	323x325x532	170	PPD200
DG200P300G		300	9425	M16	4	160	245	325x325x582	185	PPD200
DG300P50G	300	50	2076	M16	4	160	245	366x370x344	153	PPD200
DG300P100G		100	4153	M16	4	160	245	366x370x394	171	PPD200
DG300P150G		150	6229	M20	4	180	320	366x370x444	190	PPD400
DG300P200G		200	8305	M20	4	180	320	366x370x494	208	PPD400
DG300P250G		250	10382	M20	4	180	320	366x370x544	226	PPD400
DG300P300G		300	12458	—	—	—	310	366x370x594	245	PPD400
DG400P50G	400	50	2863	—	—	—	360	408x410x390	230	PPD400
DG400P100G		100	5726	—	—	—	360	408x410x440	255	PPD400
DG400P150G		150	8589	—	—	—	360	408x410x490	278	PPD400
DG400P200G		200	11451	—	—	—	360	408x410x540	302	PPD400
DG400P250G		250	14314	—	—	—	360	408x410x590	326	PPD400
DG400P300G		300	17177	—	—	—	360	408x410x640	350	PPD400
DG500P50G	504	50	3535	—	—	—	400	439x440x400	283	PPD400
DG500P100G		100	7069	—	—	—	400	439x440x450	312	ППД400
DG500P150G		150	10603	—	—	—	400	439x440x500	342	PPD400
DG500P200G		200	14138	—	—	—	400	439x440x550	371	PPD400
DG500P250G		250	17672	—	—	—	400	439x440x600	400	PPD400
DG500P300G		300	21206	—	—	—	400	439x440x650	430	PPD400
DG600P50G	610	50	4277	—	—	—	440	478x480x400	350	PPD400
DG600P100G		100	8553	—	—	—	440	478x480x450	386	PPD400
DG600P150G		150	12830	—	—	—	440	478x480x500	422	PPD400
DG600P200G		200	17106	—	—	—	440	478x480x550	459	PPD400
DG600P250G		250	21383	—	—	—	440	478x480x600	495	PPD400
DG600P300G		300	25659	—	—	—	440	478x480x650	532	PPD400





* Pressure 630 Bar

Cylinders with the capacity over 50 ton are recommended to be equipped with the safety valve.

Cylinders with the capacity over 50 ton are recommended to be equipped with float supports.



The rise of the phone tower and its holding when replacing the insulator

	Cylinders accessories p.23
	Hydraulic systems. Set-up schemes p.4
	Pumps selection table p.82
	Hydraulic accessories p.102

Aluminum hydraulic jacks with spring return

Series DGA...P...
Capacity — 20-200 ton
Pressure — 700 Bar



Models: DGA100P150, DGA20P50, DGA150P150, DGA50P150

Model	Capacity, ton	Stroke, mm	Oil working capacity, cm ³	Jack height, mm	Outer diameter, mm	Weight, kg
DGA20P50	20	50	141	152	98	3
DGA20P100		100	282	202	98	4
DGA20P150		150	423	252	98	5
DGA20P200		200	654	302	98	6
DGA20P250		250	705	352	98	7
DGA30P50	30	50	220	148	110	5
DGA30P100		100	442	198	110	6
DGA30P150		150	662	248	110	7
DGA30P200		200	882	298	110	8
DGA30P250		250	1102	348	110	9
DGA50P50	50	50	393	150	140	7
DGA50P100		100	758	200	140	9
DGA50P150		150	1175	250	140	10
DGA50P200		200	1565	300	140	12
DGA50P250		250	1955	355	140	14
DGA100P50	100	50	770	173	195	15
DGA100P100		100	1542	223	195	19
DGA100P150		150	2308	273	195	22
DGA100P200		200	3074	323	195	25
DGA100P250		250	3840	373	195	27
DGA150P50	150	50	1068	205	238	29
DGA150P100		100	2137	255	238	33
DGA150P150		150	3205	305	238	38
DGA150P200		200	4273	355	238	42
DGA150P250		250	5341	405	238	46
DGA200P50	200	50	1417	291	270	45
DGA200P100		100	2834	341	270	51
DGA200P150		150	4251	391	270	57
DGA200P200		200	5668	441	270	53
DGA200P250		250	7085	491	270	69

- Single-acting; spring return of rod;
- Made of high-tensile light alloy, two times lighter than jack with the same capacity, made of steel;
- High capacity to lateral load accommodation by means of wide guide rings;
- Lock nut of housing limits rod stroke and is able to carry the full load;
- Hard coating against mechanical damages;
- Steel support of housing and high-strength support of rod made of hardened steel to prevent them from mechanical damages;
- Serial equipment with threaded couplings 3/8-18 NPT, commonly used in world practice.

Load-lifting aluminum jacks with lock nut

Series DGA...P...G
Capacity — 20-200 ton
Pressure — 700 Bar



Models: DGA100P150G, DGA150P150G, DGA50P150G

- Single-acting; spring return of rod;
- Made of high-tensile light alloy, two times lighter than jack with the same capacity, made of steel;
- Lock nut of rod allows mechanical fixation of cargo in raised position for a long time;
- High capacity to lateral load accommodation by means of wide guide rings;
- Lock nut of housing limits rod stroke and is able to carry the full load;
- Hard coating against mechanical damages;
- Steel support of housing and high-strength support of rod made of hardened steel to prevent them from mechanical damages;
- Serial equipment with threaded couplings 3/8-18 NPT, commonly used in world practice.

Model	Capacity, ton	Stroke, mm	Oil working capacity, cm ³	Jack height, mm	Outer diameter, mm	Weight, kg
DGA20P50G	20	50	156	182	98	3
DGA20P100G		100	312	232	98	4
DGA20P150G		150	468	282	98	5
DGA20P200G		200	624	332	98	6
DGA20P250G		250	780	382	98	7
DGA30P50G	30	50	221	182	110	5
DGA30P100G		100	442	232	110	6
DGA30P150G		150	662	282	110	7
DGA30P200G		200	883	332	110	8
DGA30P250G		250	1104	382	110	9
DGA50P50G	50	50	393	200	140	7
DGA50P100G		100	785	250	140	9
DGA50P150G		150	1178	300	140	10
DGA50P200G		200	1570	350	140	12
DGA50P250G		250	1963	400	140	14
DGA100P50G	100	50	715	229	195	15
DGA100P100G		100	1431	279	195	19
DGA100P150G		150	2146	329	195	22
DGA100P200G		200	2861	379	195	25
DGA100P250G		250	3576	429	195	27
DGA150P50G	150	50	1069	264	238	29
DGA150P100G		100	2137	314	238	33
DGA150P150G		150	3206	364	238	38
DGA150P200G		200	4274	414	238	42
DGA150P250G		250	5343	464	238	46
DGA200P50G	200	50	1417	297	270	45
DGA200P100G		100	2834	347	270	51
DGA200P150G		150	4251	397	270	57
DGA200P200G		200	5668	447	270	63
DGA200P250G		250	7085	497	270	69

Aluminum hydraulic jacks with hydraulic return

Series DGA...G...
Capacity — 50-200 ton
Pressure — 700 Bar



Models: DGA100G150, DGA150G150, DGA50G150

- Double-acting; hydraulic return of rod;
- Made of high-tensile light alloy, two times lighter than jack with the same capacity, made of steel;
- High capacity to lateral load accommodation by means of wide guide rings;
- Lock nut of housing limits rod stroke and is able to carry the full load;
- Hydraulic return of rod allows quick readiness of jack for the next stage; it may be used for pulling operations as well;
- All models are equipped with safety valve preventing from the rod end overloading;
- Hard coating against mechanical damages;
- Steel support of housing and high-strength support of rod made of hardened steel to prevent them from mechanical damages;
- Serial equipment with threaded couplings 3/8-18 NPT, commonly used in world practice.

Model	Capacity, ton	Stroke, mm	Oil working capacity, cm ³	Jack height, mm	Outer diameter, mm	Weight, kg
DGA50G50	50	50	354	201	145	11
DGA50G100		100	709	251	145	12
DGA50G150		150	1063	301	145	14
DGA50G200		200	1417	351	145	16
DGA50G250		250	1771	401	145	18
DGA100G50	100	50	715	251	185	16
DGA100G100		100	1431	301	185	19
DGA100G150		150	2147	351	185	22
DGA100G200		200	2863	401	185	25
DGA100G250		250	3578	451	185	28
DGA150G50	150	50	1135	248	230	24
DGA150G100		100	2270	298	230	29
DGA150G150		150	3405	348	230	33
DGA150G200		200	4540	398	230	38
DGA150G250		250	5675	448	230	43
DGA200G50	200	50	1417	288	270	41
DGA200G100		100	2834	338	270	47
DGA200G150		150	4251	388	270	53
DGA200G200		200	5668	438	270	59
DGA200G250		250	7085	488	270	65

Medium hydraulic single-acting jacks

Capacity — 10-100 ton
 Pressure — 700 Bar
 Series DGS...P...



- Low structure of these jacks allows their use in limited space;
- Single-acting; with spring return of rod;
- Lacquer coating on jack housing prevents from corrosion;
- Quick release coupling BRS for quick connection to hydraulic system;
- Handles for jack convenient transportation;
- Chrome-plated rod;
- Corrugated portable support of jack.

Model	Load capacity, ton	Stroke, mm	Oil volume, L	Jack height, mm	Outside diameter, mm	Weight, kg
DGS10P38	10	38	67,2	88	69	2,7
DGS20P45	20	45	406	98	92	4,8
DGS30P62	30	62	348	117	101	6,3
DGS50P60	50	60	541	160	130	14,8
DGS100P57	100	75	1366	197	178	30

Pulling cylinders

Capacity — 8-100 ton
 Pressure — 700 Bar
 Series DO...P...
 Spring stroke retraction
 Series DO...G...
 Hydraulic stroke retraction



Models: D08P150, D050P150

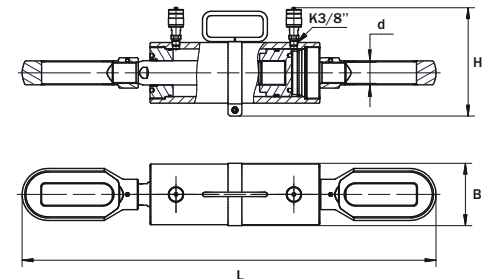

- Designed to create pulling force when performing repair, installation, assembly works and weights replacement;
- Optimum for hull of vessels tightening, steel frameworks for further fastening and welding;
- Ability to work in any position.

	Model	Capacity, ton	Stroke, mm	Oil working capacity, cm ³	Thread d, mm	Dimensions (BxLxH), mm	Weight, kg
Single-acting	D08P150	8,2	150	175	M30x2	70x150x728	13,2
	D010P150		230	M42x2	83x181x762	16	
	D010P200	10,9	200	305	M42x2	83x181x860	20
	D010P250		250	382	M42x2	85x163x960	23,7
	D030P150	33,8	150	710	M48x3	212x332x856	43
	D030P200		200	950	M48x3	212x332x920	45,5
Double-acting	D050P150	50,3	150	1056	M48x3	221x342x883	48
	D050P200		200	1408	M48x3	221x342x933	50,3
	D020G500	21,9	500	1532	M30x2	110x227x767	39
	D030G150		150	121	M30x2	159x203x788	28
	D030G200	30,2	200	161	M30x2	114x212x838	29
	D030G250		250	201	M30x2	114x212x888	32
	D030G600	50,3	600	482	M48x3	210x276x1385	80
	D050G150		150	326	M48x3	144x250x905	50
	D050G200	50,3	200	440	M48x3	144x250x955	54
	D050G250		250	615	M48x3	144x250x1005	59
	D050G500	107	500	1182	M48x3	144x250x1255	73
	D0100G150		150	754	M48x3	220x300x1300	156
	D0100G200		200	1005	M48x3	220x300x1400	165
	D0100G250		250	1257	M48x3	220x300x1500	174

Low pickup self-contained jacks

Series DA...P...K
Capacity — 2,5-30 ton
Spring stroke retraction

Designed for lifting, positioning of equipment, heavy steel frameworks, supporting heavy-loaded frames and other weights, as well as for repair, installation, dismantling, assembly, transport and storage operations, etc.;

- Rotating pump knob allows you to work in a confined space;
- The minimum height of the pickup is 19 mm;
- Built-in pump with detachable handle provides portability and ease of use;

— **Lift height on the leg is not more than 60 mm.**

(Raising legs more than the declared value, it may cause damage jack)



Attention!

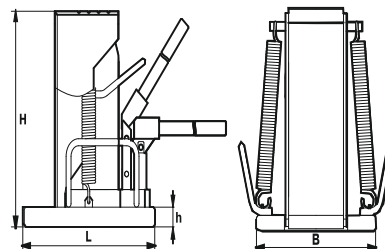

Models: DA10P150K

Модель: DA20P160K

Models	Capacity on saddle/leg, ton	Stroke, mm	Pickup height, mm	Dimensions (BxLxH), mm	Weight, kg
DA5P120K	5/2,5	110	19	160x217x212	11,2
DA10P150K	10/5	130	22	190x242x260	17,40
DA20P160K	20/10	140	25	230x275x305	33,7
DA30P160K	30/15	147	32	260x308x322	52,12

Low height cylinders

Capacity — 5-400 ton
Pressure — 700/800 Bar
Series DN...M...
Gravitation stroke retraction
Series DN...P...
Spring stroke retraction

- Low height of cylinders lets you use them in a confined space while installing and gauging of heavy equipment, for leveling bridge spans, etc.;
- Wear-resistant housing coating, applied by powder technique to protect against corrosion and external influences;
- Upon request we produce cylinders with load capacity up to 600 ton.



Models: DN140P15, DN100P15, DN50P15, DN35M15, DN20M15, DN10M15, DN5M15

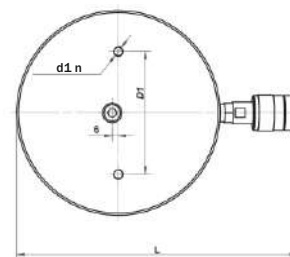
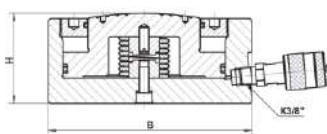

Model	Capacity, ton	Stroke, mm	Oil working capacity, cm ³	Mounting			Dimensions (BxLxH), mm	Weight, kg	Saddle
				d1, mm	n, pcs	D1, mm			
DN5M15	5,6	15	12	—	—	—	42x136x52	1,11	stroke saddle
DN10M15	11,3	15	24	—	—	—	60x149x57	1,86	stroke saddle
DN20M15	22,2	15	47	—	—	—	80x178x60	3,3	stroke saddle
DN35M15	35,8	15	75	—	—	—	100x192x66	5	stroke saddle
DN50P15	56	15	118	M10	2	80	137x215x70	7,4	stroke saddle
DN100P15	109,8	15	231	M10	2	120	180x256x79	14	stroke saddle
DN140P15	143,5	15	302	M10	2	120	200x276x88	19	stroke saddle
DN200P15	202	15	425	—	—	—	242x320x130	46,7	stroke flat saddle
DN400P15*	400	15	736	—	—	—	408x410x192	113	stroke floating saddle

* — operation pressure 800 Bar

Telescopic low height cylinders

Series DN...P..T

Capacity — 27-35 ton

Pressure — 700 Bar



Model: DN25P70T

Model: DN35P70T
(In the initial state)

Are intended for lifting and moving of loads at performance of assembly-dismantling, repair and other kinds of works in various industries.

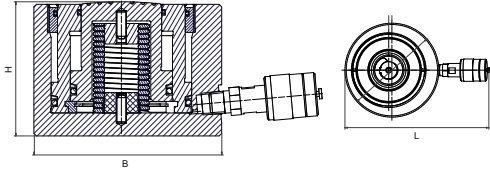

Модель	Capacity, ton	Stroke, mm	Oil working capacity, cm ³	Dimensions (BxLxH), mm	Weight, kg
DN25P70T	27	31/39	425	137x215x104	10,5
DN35P70T	35	31/39	526	147x225x105	12,5

Telescopic cylinders

Series DT...G...

Capacity — 143/56 ton

Pressure — 700 Bar

Hydraulic stroke retraction



Model: DT60G500

- Indispensable for lifting loads at high altitudes;
- Provides greater lifting height with a relatively small size;
- Safety valve in the stroke end protects the cylinder from the excess pressure if not to include couple.

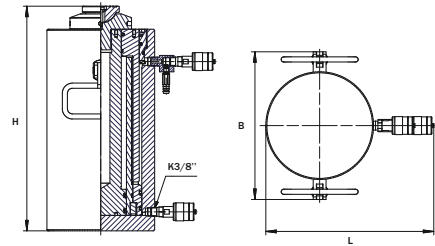

Model	Capacity, ton	Stroke, mm	Oil working capacity, cm ³	Dimensions (BxLxH), mm	Weight, kg	Saddle
DT60G500	143/56	240/260	5508	288x327x438	97,8	PPD

Hydraulic telescopic aluminum jacks

Series DTA...G...

Capacity — 65-200 ton

Pressure — 500 Bar



Models: DTA110/50G400, DTA200/100G500, DTA65/30G450

- Double-acting; hydraulic return of rods;
- Made of high-tensile light alloy, two times lighter than jack with the same capacity, made of steel;
- Sealing system of international standard, high capacity to lateral load accommodation;
- Structure with two and three rods, substantial strokes of rods at the low height of rack in initial condition;
- Hard coating against mechanical damages;
- Corrugated support made of high-tensile steel prevents rod from mechanical damages and cargo sliding;
- All models are equipped with safety valve preventing from the rod end overloading;
- Packaged design, convenience of manual transportation, light weight;
- Serial equipment with threaded couplings 3/8-18 NPT, commonly used in world practice.

Model	Capacity, ton	Stroke, mm	Oil working capacity, cm ³	Jack height, mm	Outer diameter, mm	Saddle**	Set of heads **	Weight, kg
DTA65/30/10Г280	10 - 1-st stage	95 - 1-st stage	2000	215	170	OPDA65	Kn65 (stroke increase by 260 mm)	15
	30 - 2-st stage	95 - 2-st stage						
	65 - 3-st stage	90 - 3-st stage						
DTA65/30Г185	30 - 1-st stage	90 - 1-st stage	1296	215	170	OPDA65	Kn65 (stroke increase by 260 mm)	14
	65 - 2-st stage	95 - 2-st stage						
DTA65/30Г450	30 - 1-st stage	227 - 1-st stage	3023	385	170	OPDA65	Kn65 (stroke increase by 260 mm)	24
	65 - 2-st stage	223 - 2-st stage						
DTA110/50Г185	50 - 1-st stage	90 - 1-st stage	2080	234	220	OPDA110	Kn110-1 (stroke increase by 260 mm)	24
	110 - 2-st stage	95 - 2-st stage						
DTA110/50Г400	50 - 1-st stage	195 - 1-st stage	4516	400	220	OPDA110	Kn110-2 (stroke increase by 360 mm)	41
	110 - 2-st stage	205 - 2-st stage						
DTA170/70Г500	70 - 1-st stage	250 - 1-st stage	8743	450	270	OPDA170	Kn170 (stroke increase by 500 mm)	63
	170 - 2-st stage	250 - 2-st stage						
DTA200/100Г500	100 - 1-st stage	250 - 1-st stage	10687	435	290	—	—	85
	200 - 2-st stage	250 - 2-st stage						

* Stage with the smallest diameter of piston or plunger is called the first stage, the next one is the second stage, etc. (GOST 17752-81 page 15)

** Out of the scope of supply; to be ordered separately

Hollow plunger cylinders

Capacity — 15-100 ton
 Pressure — 700 Bar
 Series DP...P...
 Spring stroke retraction
 Series DP...G...
 Hydraulic stroke retraction

Designed for lifting and handling weights, and hollow plunger makes them suitable for pressing and removing parts installed with interference on long shafts, tendon cylindering, ropes tension, etc. Can be effective when working with horizontal objects moving.

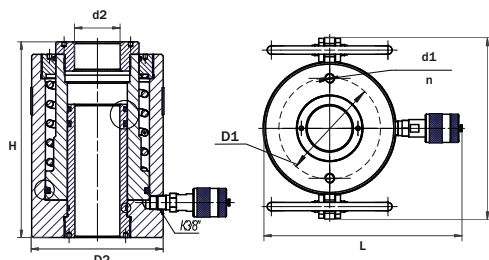

Models: DP50P75, DP20M63, DP15P50

	Model	Capacity, ton	Stroke, mm	Oil working capacity, cm ³	Mounting			Stroke hole d2, mm	D2, mm	Dimensions (BxLxH), mm	Weight, kg	Saddle
					d1, mm	n, pcs	D1, mm					
Single-acting	DP15P50	15,7	50	112	M10	2	62	29	80	80x161x173	5,7	flat saddle*
	DP15P100		100	224	M10	2	62	29	80	80x161x229	6,3	flat saddle*
	DP20P50	21,3	50	150	M10	2	65	27	98	98x178x162	7,8	flat saddle with a hole D28
	DP30P63	31,4	63	172	M10	2	85	33	115	162x207x178	11,7	flat saddle with a hole D34
	DP50P75	58,5	75	615	M12	2	120	54	158	218x238x235	27,9	flat saddle with a hole D55
Double-acting	DP100P75	105,9	75	1113	M12	2	145	80	215	275x295x235	49,0	flat saddle with a hole D80
	DP10G150	8,96	150	133	—	—	—	20	70	70x187x308	8,5	flat saddle with a hole D22
	DP10G250		250	220	—	—	—	20	70	70x187x408	10,9	flat saddle with a hole D22
	DP30G150	31,4	150	351	M10	2	85	33	115	176x250x278	19,1	flat saddle with a hole D34
	DP30G250		250	584	M10	2	85	33	115	176x250x378	25	flat saddle with a hole D34
	DP50G150	56,9	150	554	M12	2	120	54	258	218x276x310	37,2	flat saddle with a hole D55
	DP50G250		250	1089	M12	2	120	54	258	218x276x410	48	flat saddle with a hole D55
	DP100G150	105,9	150	1131	M12	2	150	80	215	275x333x335	71	flat saddle with a hole D80
	DP100G250		250	1885	M12	2	150	80	215	275x333x435	90	flat saddle with a hole D80
	DP150G200	151,3	200	5230	—	—	—	120	270	390x387x400	122	flat saddle with a hole D120
DP200G150	213	150	4477	—	—	—	100	290	410x407x350	130	flat saddle with a hole D110	

* — 3 variants of saddle: without hole, with hole D28 or M27x1,5

Mechanical steel jacks

Series DR...
 Capacity — 3-20 ton

Designed for lifting loads during installation and gauging of heavy equipment, machinery, maintenance and repair of vehicles, etc. Mechanical principle of operation and the ratchet provide full autonomy and safety at work, fixing of weight during and after lifting. The weight can be lifted by upper support having a ribbed surface, or by low pickup, allowing lifting weight, even if only a small space is available. Ratchet gears are protected from dirt and water by steel casing.



Model: DR-3, DR-10

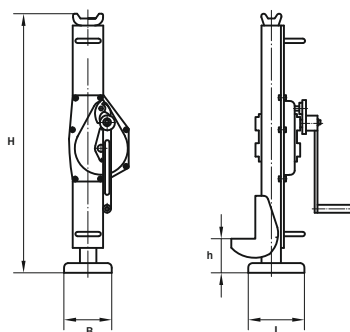

Model	Capacity on saddle/leg, ton	Pickup height, mm	Jack height, mm	Dimensions (BxLxH), mm	Weight, kg
DR-3	3/2,1	60	355	130x140x720	20
DR-5	5/3,5	80	345	150x170x740	28
DR-10	10/7	85	390	150x170x800	46
DR-16	16/11,2	160	320	155x180x900	65
DR-20	20/14	100	340	240x260x860	95

Power cylinders

Series CS...G...

Capacity — 10-200 ton

Pressure — 700 Bar

Hydraulic stroke retraction



Models: CS200G320, CS100G500, CS100G320

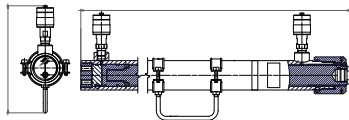

CS10G500

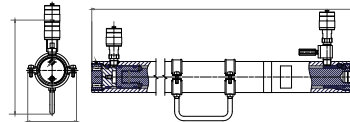

CS15G500

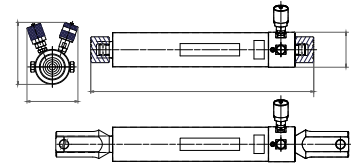

CS100G160

Models in this series are designed for assembly, dismantling, repair and other types of work in different industrial branches.

— Can be applied effectively when working with horizontal objects moving when the hydraulic stroke retraction ensures quick preparation of the cylinder for the next cycle.

— Elastic multi-lip seals and secure spacers allow the cylinder to work with significant radial loads on the stroke

Model	Capacity, ton		Stroke, mm	Oil working capacity, cm ³	Mounting			Internal thread stroke	Dimensions (BxLxH), mm	Weight, kg	Saddle
	pushing	pulling			d1, mm	n, pcs	D1, mm				
CS10G500	11,3	2,3	500	628	M10	2	28	M27x2	100x219x683	14,8	ПД10
CS15G500	14,1	5,0	500	628	M10	2	38	M27x2	110x249x686	19	ПД10
CS20G250GZ*	20	13	250	300	external thread on the housing M27x3			external thread stroke M27x3	124x151x543/713	20,3	2 grooved saddle + 2 links

* - The actuator with built-in check valves. For the connection of the cylinder requires high pressure hose with coupling and drain kit



CS200G1250SH as part of the installation to puncture the ground

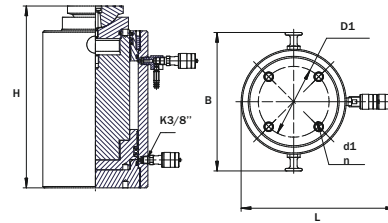

The advantage of the hydraulic cylinders Enerpred:

- A safety valve on the rod end;
- Availability of floating support from cylinders of 50 tons.

Model	Capacity, ton	Stroke, mm	Oil working capacity cm ³	Mounting			Internal thread stroke	Dimensions (BxLxH), mm	D, Inner thread of cylinder	Weight, kg	Saddle
				d1, mm	n, pcs	D1, mm					
CS50G160	55	160	1150	—	—	—	M48x3	180x220x331	140	30	PPD100
CS50G320		320	2300	—	—	—	M48x3	180x220x509	140	52	PPD100
CS50G500		500	3700	—	—	—	M48x3	180x220x733	140	68	PPD100
CS100G160	108	160	1256	M16	4	110	M68x3	308x296x415	180	59	PPD100
CS100G250		250	1963	M16	4	110	M68x3	308x296x505	180	69	PPD100
CS100G320		320	2512	M16	4	110	M68x3	308x296x575	180	77	PPD100
CS100G400		400	3142	M16	4	110	M68x3	308x296x655	180	86	PPD100
CS100G500		500	3925	M16	4	110	M68x3	308x296x755	180	98	PPD100
CS100G630		630	4945	M16	4	110	M68x3	308x296x885	180	113	PPD100
CS100G800		800	6280	M16	4	110	M68x3	308x296x1055	180	133	PPD100
CS100G1000	1000	7900	M16	4	110	M68x3	308x296x1255	180	169	PPD100	
CS200G160*	201+220	160	2462	M20	4	165	M95x3	323x356x430	245	107	PPD200
CS200G250*		250	4004	M20	4	165	M95x3	323x356x520	245	125	PPD200
CS200G320*		320	4924	M20	4	165	M95x3	323x356x590	245	140	PPD200
CS200G400*		400	6154	M20	4	165	M95x3	323x356x670	245	156	PPD200
CS200G500*		500	7693	M20	4	165	M95x3	323x356x770	245	177	PPD200
CS200G630*		630	9693	M20	4	165	M95x3	323x356x900	245	203	PPD200
CS200G800*		800	12309	M20	4	165	M95x3	323x356x1070	245	237	PPD200
CS200G1000*		1000	15386	M20	4	165	M95x3	323x356x1270	245	277	PPD200
CS200G1250*		1250	19232	M20	4	165	M95x3	323x356x1520	245	328	PPD200
CS200G1250SH*		220	1250	19232	M20	4	165	M95x3	223x335x1665	245	372

Hydraulic cylinders with eye lugs up to 700 Bar

Series CS...G...

Capacity — 50-200 ton

Pressure — 700 Bar



Model: TSG200G1250-22

Eye lug type: 22 – with eye lugs of housing/rod and ball bearings

Hydraulic cylinders produced by ENERPRED are designed for lifting or transportation of cargoes during assembling and dismantling as well as other works in various spheres of industry.

Hydraulic cylinders may be equipped with eye lugs of various execution for connection with equipment in processing lines, in lifting mechanisms, etc.

Types of eye lugs execution

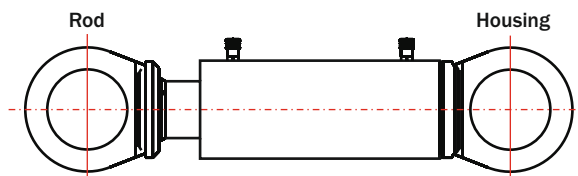

No.	Designation
01	with eye lug of rod
02	with eye lug of rod and ball bearing
10	with eye lug of housing
20	with eye lug of housing and ball
11	with eye lugs of housing/rod
22	with eye lugs of housing/rod and ball bearings

Standard list of equipment:

1. Sleeve (housing of cylinder)
2. Rod
3. Rod sealing
4. Piston
5. Piston sealing
6. BRS (quick release couplings)
7. Housing eye lug
8. Rod eye lug

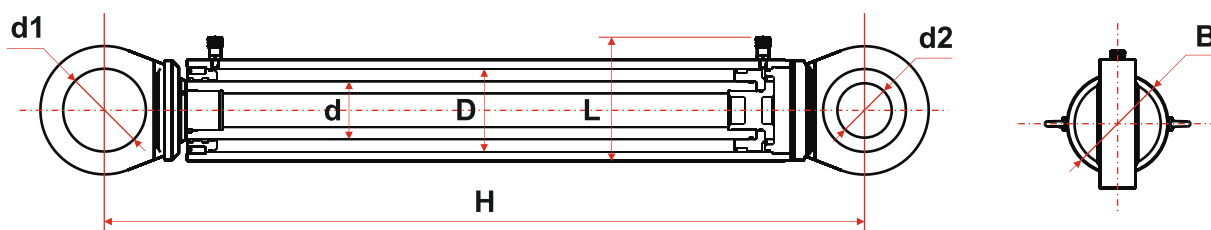
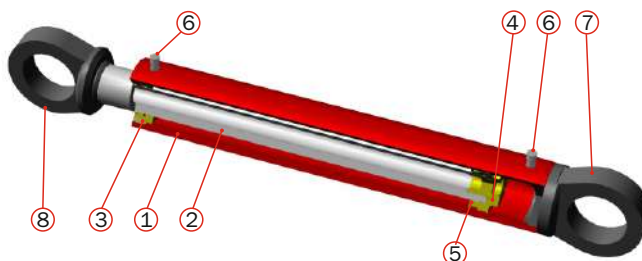

Model	Capacity, ton		Stroke, mm	Oil working capacity, cm ³	Dimensions, mm			Eye lug diameter, mm		Weight, kg
	Pushing	Pulling			H	B	L	without bearing (d1)	with bearing (d1)	
CG50G500	50	30	500	3700	1030	146	226	75	50	68
CG50G900			900	6900	1287					122
CG100G400	100	55	400	3200	1015	180	260	178	100	136
CG100G500			500	3900	1145					148
CG100G630			630	5000	1245					163
CG100G800			800	6300	1415					183
CG100G1000			1000	7900	1615					219
CG200G400			200	112	400					6200
CG200G500	500	7700			1085	283				
CG200G630	630	9700			1215	310				
CG200G800	800	12300			1285	344				
CG200G1000	1000	15400			1585	384				
CG200G1250	1250	19200			1835	435				

Hydraulic cylinders may be manufactured according to the customer's technical specifications

* Parameters and weight are specified for eye-lugs of housing/rod and ball bearings

Load-lifting trolley jacks

Series DPV, DPT
Capacity — 55-200 ton
Pressure — 50-70 Bar



Model: DPV100E in uncoupled and coupled position

Trolley jacks of DVP and DPT series are designed for lifting of quarry equipment, railway wagons and other heavy machinery.

Advantages of trolley jacks:

- Floating support for decrease in radial load on jack;
- Exclusive structure of extension screw with fixing device;
- Portable steel foundation of jack with possibility of remote operation;
- Remote control for maximum protection of operator;
- Rigid closed frame of structure;
- Polyurethane wheels made in Germany provide high wearing capacity, high manoeuvrability;
- Hydraulic lock to prevent spontaneous lowering of cargo;
- It is possible to use station for other equipment and tools.

Trolley jacks with steel cylinders, integrated extension screw, DPV series

Model	Drive of oil pump station	Pressure, Bar	Capacity, ton	Base altitude, mm	Stroke, mm	MAX height (without extension screw), mm	Stroke of extension screw, mm	MAX height, mm	Control	Weight, kg
DPV55E	electric	700 Bar	55	580	360	940	320	1300	manual panel	190
DPV55P	pneumatic								manual panel	
DPV55B	gasoline								—	
DPV100E	electric	700 Bar	100	600	360	960	320	1300	manual panel	220
DPV100P	pneumatic								manual panel	
DPV100B	gasoline								—	
DPV150E	electric	700 Bar	150	670	360	1030	320	1370	manual panel	260
DPV150P	pneumatic								manual panel	
DPV150B	gasoline								manual panel	
DPV200E	electric	700 Bar	200	700	360	1060	320	1400	manual panel	260
DPV200P	pneumatic								manual panel	
DPV200B	gasoline								—	

Trolley jacks with aluminum telescopic cylinders, DPT series

Model	Drive pump	Pressure, Bar	Capacity, ton	Stroke, mm	Base height, mm	Height in extended position, mm	Control	Weight, kg
DPT60/30E	electric	500 Bar	60 - 1-st stage	450	580	1200	manual panel	170
DPT60/30P	pneumatic						manual panel	
DPT60/30B	gasoline						—	
DPT100/50E	electric	500 Bar	100 - 1-st stage	450	600	1200	manual panel	190
DPT100/50P	pneumatic						manual panel	
DPT100/50B	gasoline						—	
DPT160/70E	electric	500 Bar	160 - 1-st stage	500	670	1270	manual panel	220
DPT160/70P	pneumatic						manual panel	
DPT160/70B	gasoline						—	
DPT200/100E	electric	500 Bar	200 - 1-st stage	500	700	1300	manual panel	220
DPT200/100P	pneumatic						manual panel	
DPT200/100B	gasoline						—	

Safety valve



Model: KP

Safety valve (hydraulic lock with manual control) is designed to hold the load by hydraulic cylinder, automatically locks the cylinder working cavity after the loading, causing the hydraulic cylinder be under load for a long time without inadvertent movement.

Hydraulic lock



Model: GZ

Hydraulic lock with hydraulic control is designed to hold the load by hydraulic cylinder, automatically locks the cylinder working cavity after the loading, causing the hydraulic cylinder be under load for a long time without inadvertent movement. Hydraulic lock is a safety device and must be installed on all cylinders, which are held under load for a long time, in case of damage to the high pressure hoses. Can be applied only to double-acting hydraulic cylinders. Opening is performed automatically by retraction space hydraulic fluid control signal.

Model	Nominal pressure, Bar	Max resistance Nm	Connection threads	Dimensions (BxLxH), mm	Weight, kg
KP	800	1,5	K3/8"	50x101,5x114,5	1,32

Model	Nominal pressure, Bar	Opening pressure, MPa, max	Connection threads	Dimensions (BxLxH), mm	Weight, kg
GZ	800	6	K3/8"	50x78x122	3,1

Saddles

Flat saddle



Saddles are set on the cylinder stroke, protecting it from damage.

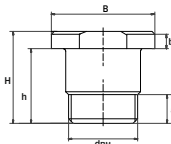

Grooved saddle



Grooved saddles prevent weight from sliding.

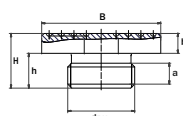

Serrated saddle



The surface of a serrated saddle prevents weight from sliding.

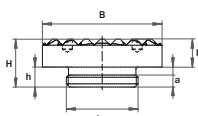

Tilt saddle



Tilt saddles are designed to reduce radial loads on the cylinder stroke at its eccentric loading. Set on the outer end of the stroke and attached by ball detent.

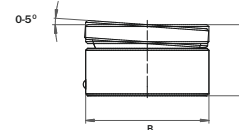

Model	Capacity, ton	Stroke d out. for saddle, mm	Stroke h for saddle, mm	a, thread, mm	b, mm	Dimensions (BxLxH), mm	Weight, kg
Flat saddle							
PD5	5,6	M16x1,5	10	6	6	22x25x16	0,035
PD10	11,3/14,1	M27x2	14	10	6	30x35x20	0,1
PD15	14,1	M24x1,5	26	10	6	32x36x32	0,147
PD20	22,2	M27x2	14	—	8	46x48x22	0,166
Grooved saddle							
PD100	56/80,8/109,8	72	15	—	—	72x72x20	0,623
PD200	162/202	130	20	—	—	130x130x25	2,5
Serrated saddle							
PD35	22,2/35,8	M36x1,5	10	6	14	60x60x24	0,345
Tilt saddle							
PPD20	22,2	M27x2	16	12	22	44x44x38	0,313
PPD35	35,8	M36x1,5	16	12	25	60x60x41	0,65
PPD100	109,8	72	15	—	—	72x72x40	1,2
PPD200	162/202	130	20	—	—	130x130x75	7,4
PPD400	300/400/504/603	160	60	—	—	160x160x90	14

Base plates



Designed to create a solid base surface and to provide steadiness of the cylinder at its operation.

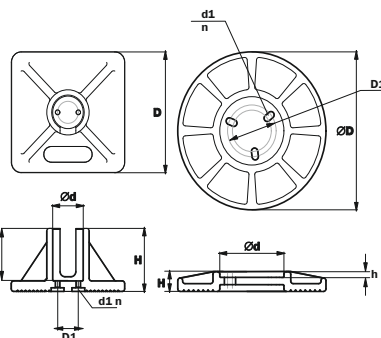

Model	Capacity, ton	Diameter, d, mm	Mounting			h, mm	Dimensions (BxLxH), mm	Weight, kg
			d1, mm	holes n, pcs	D1, mm			
OPD10	11,3	62	9	2	42	100	230x230x120	11,3
OPD15	14,1	72	9	2	38	100	230x230x120	11,4
OPD20	22,2	85	11	2	45	100	Д250x120	11,4
OPD35	35,8	112	13	2	50	11	Д305x38	11
OPD50	56	132	13	3	70/100	11	Д305x38	11

Hydraulic frame-closed pipe benders

Series TG...
Bending capacity – 11-14 ton
Diameter of bending pipes— 8-50 mm
Pressure – 700 Bar



Model: Tg1550

Designed for bending water and gas pipes in a cold condition.

- Lightweight and compact design in aluminum alloy allows for on-site installation of piping and plumbing systems;
- Minimal time of preparation of benders to work;
- Maximum bending - 90°;
- Complete with the set of punches to the appropriate range of bend radius;
- To control the accuracy of bending are equipped with angle indicator.

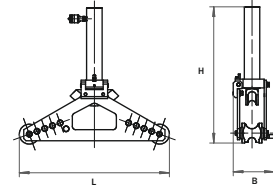

Model	Diameter of pipe/bend radius, mm	Thickness of pipe, mm	Pipe wall thickness, mm	Dimensions (BxLxH), mm	Weight*, kg	Recommended pump
TG1032	8/60, 10/70, 15/90, 20/100, 25/135, 32/170	11,3	2,00-4,00	158x530x394	17	HPF-7010
TG1550	15/90, 20/100, 25/135, 32/170, 40/205, 50/240	14,1	2,35-4,50	170x680x621	33,3	HPF-7010

* — weight including the set of punches

Hydraulic frame-closed pipe benders with built-in pump

Series TG...R...
Bending capacity – 10 ton
Diameter of bending pipes – 10-50 mm



Model: TG1R1450

Model: TG1R1050

— Equipped with built-in pumps with manual transmission, enabling operation in the absence of power supply;

— Complete with the set of punches to the appropriate range of bend radius;

— The angle of the bend – 90°.

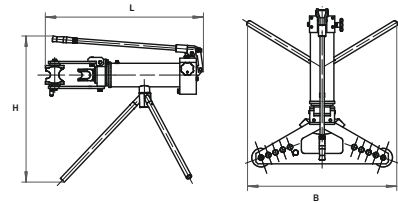

Model	Diameter of pipe/bend radius, mm	Banding capacity, t	Thickness of pipe, mm	Dimensions (BxLxH), mm	Weight*, kg
TG1R1050	15/90, 20/100, 25/135, 32/170, 40/205, 50/240	10,2	2,35-4,5	730x750x820	63
TG1R1450	10/70, 15/90, 20/100, 25/135, 32/170, 40/205, 50/240	10,2	2,00-4,5	730x841x830	106,8

* — weight including the set of punches

Power frame-closed pipe benders

Series TG...E...
Bending capacity – 10-20 ton
Diameter of bending pipes – 10-100 mm



Model: TG1E1050

Model: TG1E1880

Designed for bending water and gas pipes in a cold condition.

— Model TG1E1880 has fixing holes in the base for reliable stationary mounting on a foundation. Bender has an internal motor pump with supply voltage 380V.

Equipped with a thermal switch, which helps prevent damage from overheating. Comes with the set of punches to the appropriate range of bend radius;

— The angle of the bend - 90°

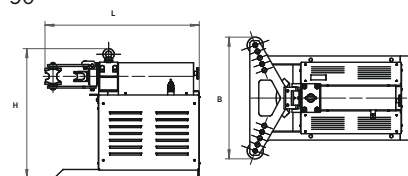

Model	Diameter of pipe/bend radius, mm	Banding capacity, t	Thickness of pipe, mm	Dimensions (BxLxH), mm	Weight*, kg
TG1E1050	15/90, 20/100, 25/135, 32/170, 40/205, 50/240	10,2	2,35-4,50	730x742x780	104
TG1E1880	10/70, 15/90, 20/100, 25/135, 32/170, 40/205, 50/240, 65/320, 80/425, 100/650	20,4	2,00-5,00	1000x955x726	210
TG1E20100	10/70, 15/90, 20/100, 25/135, 32/170, 40/205, 50/240, 65/320, 80/425, 100/650	20,4	2,00-5,00	720x860x830	179

* — weight including the set of punches

Manual pullers

Series SV. ..
Capacity — 1,3-10 ton
Spread range — 30-320 mm

Designed for efficient removal of parts, set with tension when required little effort;
 — 2 variants of assembly: 2-jaws to work in a confined space, 3-jaws - for secure grip;
 — Centering mechanism provides simplicity and ease of use, eliminating distortions and slipping of grips off removable parts.



Model: SV5, SV2

Torque wrenches page. 43

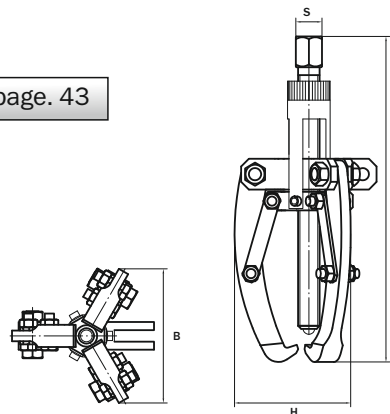

Model	Capacity, ton	Number of jaws	Spread range, mm	Max reach, mm	Dimensions (BxLxH), mm	Weight, kg
SV2	1,3/2	2/3	30...90	70	80x240x80	1,5
SV5	3,3/5	2/3	45...220	130	150x350x140	4,5
SV10	6,6/10	2/3	60...320	170	210x475x205	9,4

Manual pullers "POSILOCK"



Series SV. . .
Capacity — 1-40 ton
Spread range — 6-635 mm

— Effectively dismantling the parts installed with an interference fit;
 — Made of high quality hardened steel;
 — Safety cage forwards jaws and provides quick installation, the hard grip and increased safety by preventing slipping of legs off removable parts.



Model: SV102

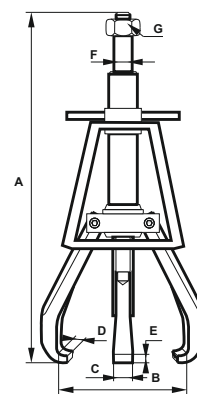

Model	Capacity, ton	Number of jaws	Spread range, mm	Max reach, mm	Dimensions, mm						Weight, kg
					A	C	D	E	F	G	
SV102	1	3	6-82	57	138...184	6	3	3	8	-	0,3
SV103	2	3	6-114	76	178...237	8	4	3	10	-	0,6
SV104	5	3	13-127	102	259...337	16	4	4	14	19	1,86
SV106	10	3	13-178	152	327...456	19	5	6	17	19	3,6
SV108	17	3	19-305	203	422...562	22	8	7	20	25	6,4
SV110	20	3	25-381	246	498...661	25	8	9	20	25	7,3
SV113	30	3	64-457	305	671...902	32	8	13	30	32	20
SV116	40	3	76-635	356	813...1058	38	13	16	31	32	31

**Trolley Hydraulic pullers
“POSILOCK”**

Series PH...
Capacity — 100-200 ton
Single-acting and Double-acting



Model: PH-123T

- Trolley 100-ton and 200-ton hydraulic pullers PosiLock provide maximum traction in the works related to the dismantling of large gears, pulleys, wheels, hubs, and other details;
- Removable trolley with hydraulic drive, on which there set pullers, makes it more secure to raise them to a height of 1,52 m by hydraulic control jaws.
- Puller can be used in both horizontal and vertical hanging;
- Equipped with adjustable jaw tips, jaw guides;
- Models PH-123T and PH-123TDA have two variants of assembly: 2-and 3-jaws
- Upon request it is possible to deliver special interchangeable tips (tips HT-1180 are included by default in all models (Fig.))

	Model	Capacity, ton	Number of jaws	Spread (A), mm	Overall length, mm	Reach (C), mm	Jaw length (D), mm	Tip dimensions, mm			Weight, kg	Recommended pump
								E	F	G		
single-acting	PH-102T	100	2	191-1778	1956	1270	1346	32	89	89	771	NEE-1,6i10T(F)1
	PH-100T		3	191-1778	1956	1270	1346	32	89	89	885	NEE-1,6i10T(F)1
	PH-123T		2/3	191-1778	1956	1270	1346	32	89	89	907	NEE-1,6i10T(F)1
	PH-102TV*		2	191-1778	1956	1270	1346	32	89	89	816	NEE-1,6i10T(F)1
double-acting	PH-102TDA	100	2	191-1778	1956	1270	1346	32	89	89	816	NEE-1,6i10T(F)1
	PH-100TDA		3	191-1778	1956	1270	1346	32	89	89	930	NEE-1,6i10T(F)1
	PH-123TDA		2/3	191-1778	1956	1270	1346	32	89	89	953	NEE-1,6i10T(F)1
	PH-102DATV*		2	191-1778	1956	1270	1346	32	89	89	816	NEE-1,6i10T(F)1
	PH-200T	200	4	203-1778	1994	1219	1346	32	89	89	1882	NEE-1,6i20T(F)1

* Vertical

100-ton pullers

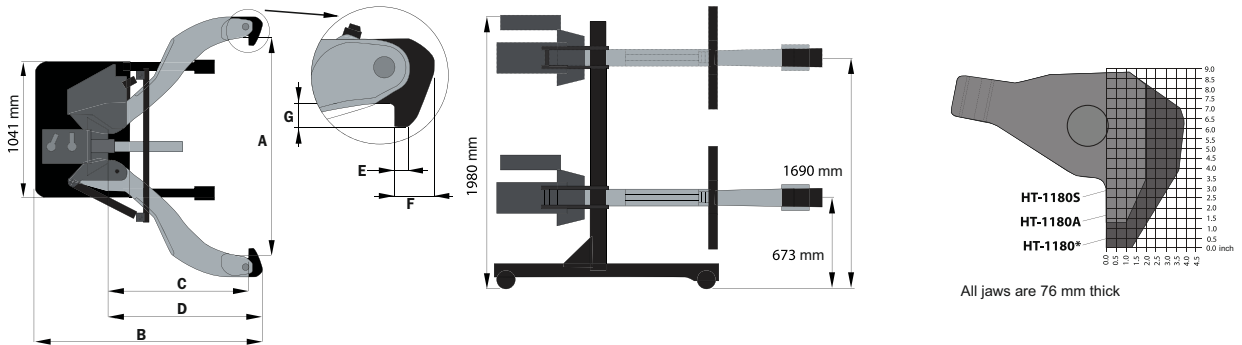

200-ton pullers

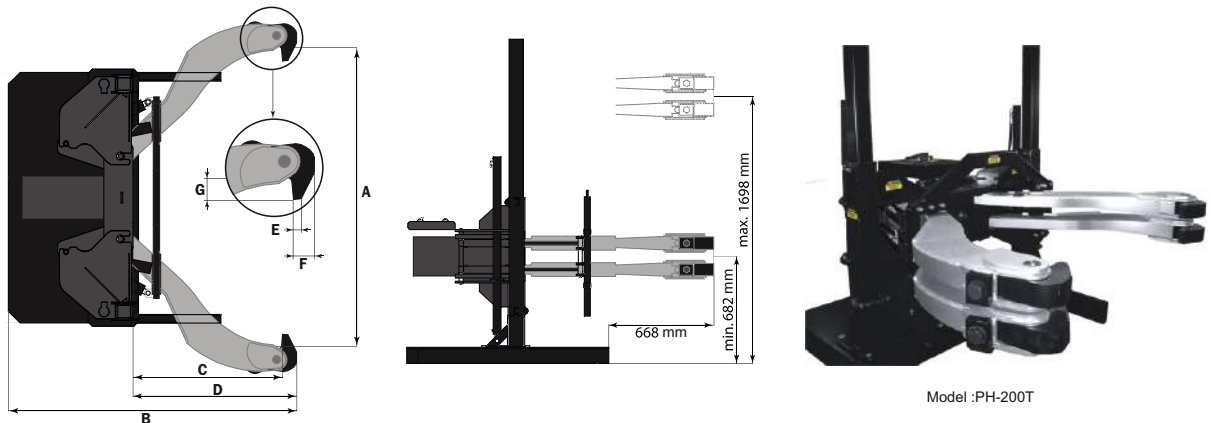

Model :PH-200T

Trolley hydraulic pullers

Series SGT...

Capacity — 50-100 тс

Reach — 720-1220 мм



Model: SGT2/3501250

- Two versions of puller assembly: 2-gripper and 3-gripper;
- Hydraulic lifting system with foot drive for easy and exact fixation of puller position;
- Self-centering structure allows to fix object uniformly and automatically by means of legs;
- Easy system of legs control prevents from legs slipping down from object being removed;
- Puller may be adjusted on five positions of puller axis lifting and lowering for precise positioning;
- Curve sheaves of carriage provide mobility;
- Electrical pump station with 2-position control valve.

Model	Capacity, ton	Rod stroke, mm	Number of grips, pcs.	Reach, mm	Spread range, mm	Carriage hoisting height, max, mm	Overall dimensions, BxLxH (mm)	Power supply	Weight, kg
SGT2/3501250	50	330	2/3	720	1250	1093	767x2274x1047	220 V, 50 Hz	391
SGT2/31001500	100	270	2/3	1220	1500	1330	1030x2772x1334	220 V, 50 Hz	1100

* — Насосная станция входит в комплект поставки

Pump station for	Tank nominal volume, cm ³	Max pressure, Bar	Capacity, cm ³ /min	Control valve	Single-phase motor	Weight, kg
SGT2/3501250	8000	700	260	2-position	220 V, 50 Hz	31
SGT2/31001500	11000	700	650			37

50-ton pullers

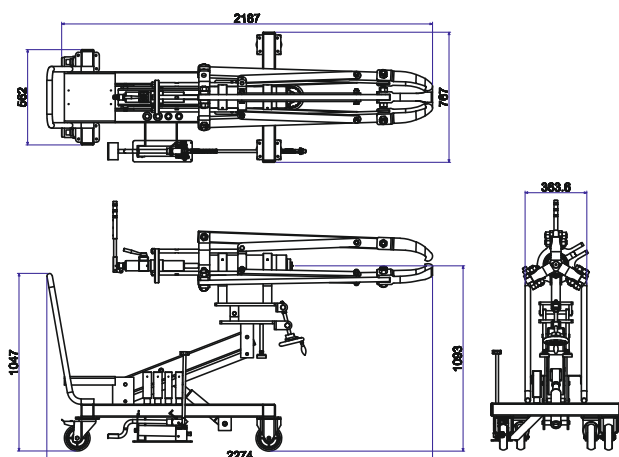

Model: SGT2/3501250

100-ton pullers

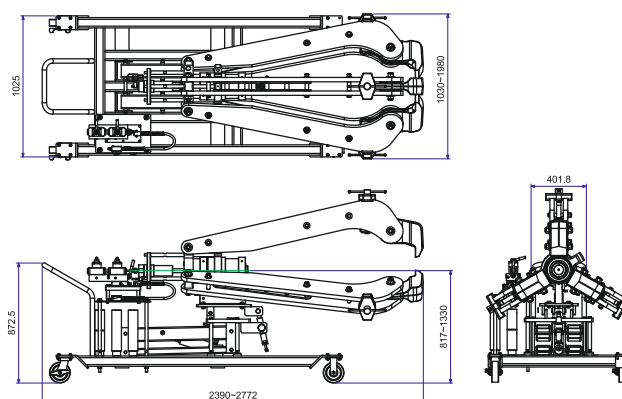

Model: SGT2/31001500

Hydraulic pullers

Series SG...

Capacity — 5-56 ton

Spread range — 30-600 mm

Pressure — 700 Bar



Model: SG6

- Pullers are designed to dismantle parts of equipment with an interference fit, and are a means of mechanization for different kinds of repair work;
- There are two variants of assembly: 2 jaws to work in a confined space, and 3 jaws for a more secure grip of the parts;
- Complete with tips that let you work with shafts with different shapes of centre holes;
- Two holes on the cross, which allow for changing the depth and diameter of the puller grip;
- To compensate for the distance between the stroke and a part cylinder can be moved along the axis.

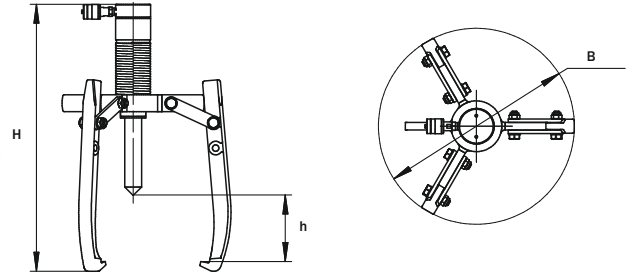

Model	Capacity, ton	Number of jaws	Spread range, mm	Max reach, mm	Stroke, mm	Dimensions (BxLxH), mm	Weight, kg	Recommended pump
SG6	6	3; 2	40-330	190	50	170x377	5,1	NRG-7010
SG8	8	3; 2	50-350	236	80	197x446	6,9	NRG-7010
SG12	12	3; 2	60-375	269	100	225x501	11	NRG-7010
SG20	20	3; 2	70-520	343	100	291x601	21,5	NRG-7010
SG30	30	3; 2	80...450	331	100	339x598	37	NRG-7010
SG335	35	3; 2	150-500	555	150	539x877	75	NRG-7010
SGSG6U	35	3; 2	500-890	744	150	1037x1061	157	NRG-7010
SG356	56	3; 2	300-600	543	150	587x875	106	NRG-7020
SG50-1200	56	3; 2	400-1200	370	150	950x1030	225	NRG-7020

Hydraulic pullers with centering of the grip mechanism

Series SG...

Capacity — 5-100 ton

Spread range — 20-600 mm

Pressure — 700 Bar



Models: SG305, SG315

— Self-centering design of the puller jaws provides fixed position of the grips in the entire zone of removal;

— Model SG315 has the ability to grip for internal and external circuit of a part.

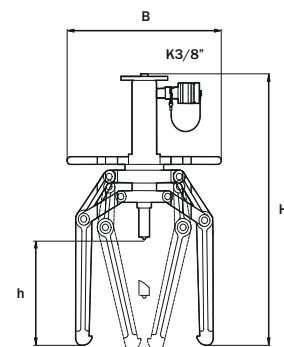

Model	Capacity, ton	Number of jaws	Spread range, mm	Max reach, mm	Stroke, mm	Dimensions (BxH), mm	Weight, kg	Recommended pump
SG305	5	3; 2	20-180	167	100	263x412	5,6	NRG-7010
SG315	15	3; 2	35-380	245	250	335x700	21,3	NRG-7010
SG320	20	3	56-450	302	360	330x874	36	NRG-7020
SG3100	100	3	300-600	595	150	640x1424	263	NRG-7035
SG3100-1	100	3	150-600	1250	150	652x2068	352	NRG-7035

Hydraulic puller with built-in pump

Series SGA. . .
Capacity — 6-30 ton
Spread range — 40-550 mm



Model: GSA8



Model: SGA6 in the case



Model: Protection net

- Ideal for removing set with tension sleeves, bearings, sprockets, gears and pulleys;
- Built-in pump with a removable telescoping handle, rotating at 360°, allows you to quickly and efficiently complete the work on the dismantling of parts;
- Corrosion protection of parts;
- Built-in pressure relief valve protects the puller from overload;
- Pullers are available in convenient and durable plastic cases;
- Includes protection net.

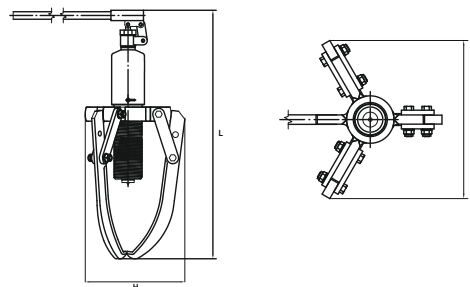

Pullers with built-in pump "Rikline" p.109

Model	Capacity, ton	Number of jaws	Spread range, mm	Max reach, mm	Stroke, mm	Dimensions (BxLxH), mm	Weight*, kg
SGA6	6/4	3/2	40-330	205	65	150x455x150	6,14
SGA8	8/5	3/2	50-350	220	80	170x480x175	7,7
SGA12	12/8	3/2	60-375	265	80	190x525x196	9,82
SGA20	20/13	3/2	70-520	275	85	250x560x280	22,8
SGA30	30/20	3/2	80-550	260	85	300x560x330	32,3

* — weight of 3-jaw puller without case

Universal pullers

Series SGU. . .
Capacity — 10-35 ton
Spread range — 70-260 mm
Pressure — 700/220 Bar

- Two variants assembly - for removing parts with a collar and with internal jaw of details which were set in the hole;
- To control the pressure at work with internal jaw, it is recommended to equip the puller with pressure gauge.



Model: SGU15

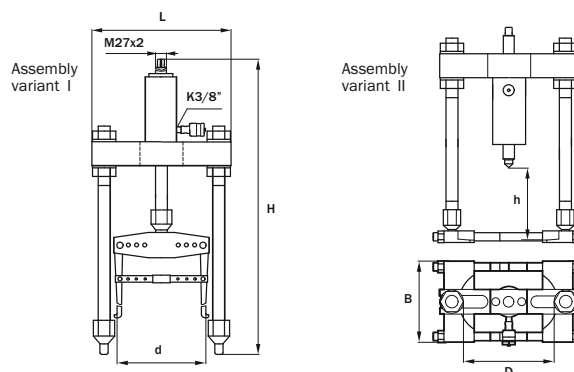

Model	Assembly variant	Capacity, ton	Pressure, Bar	Reach h, mm	Inner diameter d, mm	Outer diameter D, mm	Dimensions (BxLxH), mm	Weight, kg	Recommended pump
SGU15	I	5	220	212	75-230	75-230	166x350x900	36	NRG-7010
	II	15,7	700	30-300	—	70-260	205x360x805		

Hydraulic bearing pullers

Series SGH...
Capacity — 10-35 ton
Spread range — 35 - 420 mm



Model: SGH10

Designed for removing gears, bearings, sprockets, couplings, impellers, pulleys and other components, which were set with interference, which can be damaged when removing with the conventional pullers;

- Construction of the bearing provides a secure grip in the case where the shape of the part does not allow using a conventional puller;
- Provides the pulling to the inner ring of the bearing - the load is transmitted through the rolling elements, which minimizes the risk of damage to the bearing;
- Pullers include a single-acting cylinder with spring stroke retraction, which can be removed and used separately.

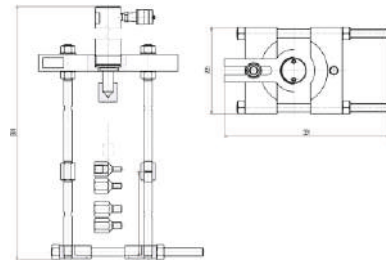

Model	Capacity, ton	Reach h, mm	Spread range of released, mm	Dimensions (BxLxH), mm	Weight, kg	Recommended pump
SGH10	11,3	176, 376	35-280	205x391x684	20	NRG-7010
SGH35	35,8	30, 280, 530	80-420	340x664x1025	90	NRG-7020

Hydraulic bearing pullers with built-in pump

Series SGHA...
Capacity — 6-12 ton
Spread range — up to 375 mm



Model: SGHA8 in the case



Model: SGHA8 assembled

- Built-in pump with a removable telescoping handle, rotating at 360°, allows you to quickly and efficiently complete the work on the dismantling of parts;
- Corrosion protection of parts;
- Integrated pressure relief valve protects the puller from overload;
- Construction of the bearing provides a secure grip in the case where the shape of the part does not allow using a conventional puller;
- Pullers are available in convenient and durable plastic cases;
- Includes protection net;
- There are puller sets both with the bearing and with the jaws.

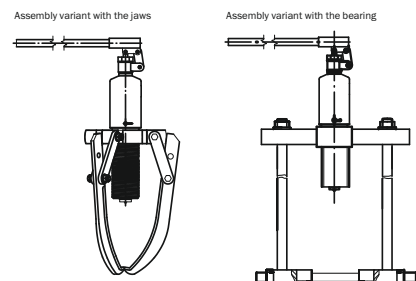

Model	Capacity, ton	Spread, mm	Reach, mm	Stroke, mm	Weight, kg
SGHA6	6	330/140	205/240	65	17,1
SGHA8	8	350/140	220/250	80	19,2
SGHA12	12	375/160	265/280	80	33,5

Pressers-pullers

Series PGA..., PG..., PV...
Capacity – 6-12 tons



“3 in 1” unique structure of presser-puller allows to use one tool for quick and safe parts pressing, parts removal (internal and external grip). Presser-puller is ideal for mounting and dismantling of various parts, including plugs, wheels, bearings, gears and rollers

- Pumping module of double action provides capacity both for pressing and removal of parts put with tension;
- Unique structure of legs allow to perform operations on parts removal and pressing without their dismantling;
- 3-gripper structure provides reliable grip;
- Puller centering mechanism with internal grip provides equal distribution of load excluding grips sliding from part being removed;
- Integrated safety valve provides safe operation and protects working mechanisms from damages; provides permanent operation with rated pressure extending service life of tool.

Pullers

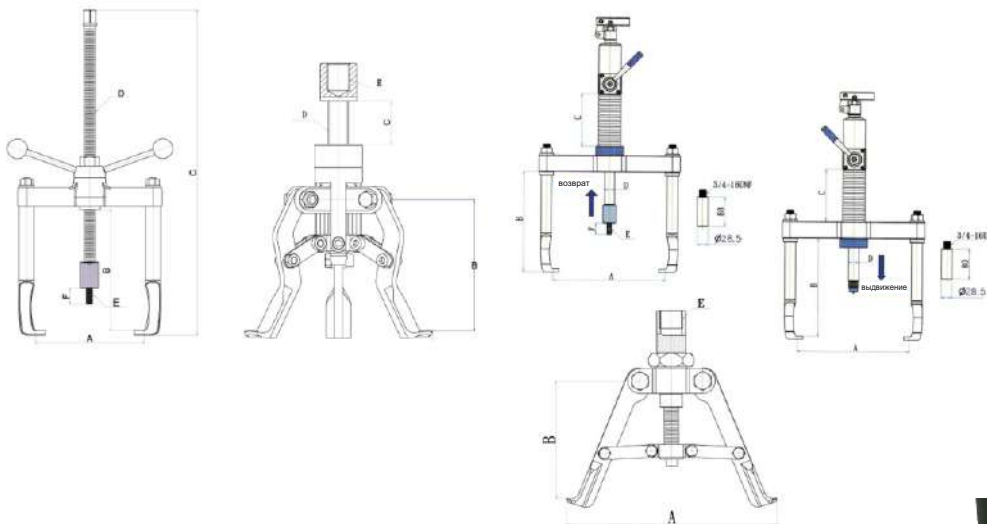

Model	Type of operation	Capacity, ton	A (mm)	B (mm)	C (mm)	D (mm)	E (mm)	F (mm)	Dimensions (BxH), mm	Weight with case, kg
PGA1208	Pressings	8	44-280	270	135	28	M12xP1.75	34	275x552...662	36
	Removal (external grip)	12	85-300	260-340	135	28	-	-		-
	Removal (internal grip)	8	110-220	127-154	-	-	1"-12UNF	-		-
PG1208	Pressings	8	44-280	270	135	28	M12xP1.75	34	380x535...615	33.9
	Removal (external grip)	12	85-300	260-340	135	28	-	-		-
	Removal (internal grip)	8	110-210	127-154	-	-	1"-12UNF	-		-
PV0806	Pressings	6	29-186	245...325	-	3/4"-10UNC	M12xP1.75	30	275x330...610	12
	Removal (external grip)	8	70-206	230...310	-	3/4"-10UNC	-	-		-
	Removal (internal grip)	6	55-150	105-115	-	5/8"-11UNC	3/4"-10UNC	-		-

Hydraulic presses

Series PSM..., PPK...
Capacity — 10-200 ton
Stroke — 150-300 mm
Pressure — 700 Bar

- Designed for mounting and removing, straightening and bending parts and other kinds of work;
- To work with small and medium-sized parts presses of series PSM are used, the models of the series PPK are used when working with large parts;
- Hydraulic stroke retraction on the models of the series PPK ... G can speed up the work;
- The horizontal movement of the table PPK200 provides the convenience of working with large parts.



Model: PPK200



Model: PPK100G150



Model: PSM15

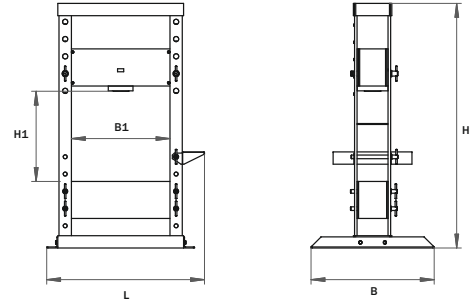

Pumps p. 82

 High pressure hoses
p. 107

 Pressure gauges
p. 103

Model	Capacity, ton	Stroke, mm	Overall dimensions of operating space, mm (B1xh1)	Dimensions (BxLxH), mm	Weight, kg	Recommended pump
PSM10	10	150	358x398	220x422x733	49	NRG-7010
PSM15	15	250	360x420	200x472x882	69,2	NRG-7010
PPK50	56	150	800x1290	1000x1280x1985	358	NRG-7020
PPK50G150	56	150	1295x800	1200x1000x1985	386	NRG-7080R,NER...,NEE...
PPK100G150	100	150	1000x1132	500x1286x2005	698	NRG-7080R,NER...,NEE...
PPK100G300	100	300	1000x1130	500x1286x2155	716	NRG-7080R,NER...,NEE...
PPK200	200	300	1200x1200	2070x2100x3330	2360	NER..., NEE...
PPK200S	200	300	1200x1284	4100x2100x3330	4300	NER..., NEE...

Testing machines for jacks

Series SDI...
Capacity — 100-150 ton

Stand is designed to test hydraulic and mechanical jacks with capacity up to 100 tons and to determine the exact capacity developed by the jack under test. Stand can be used as a press as well.

- When tested in statics, jack under test creates a load on strain sensor; value of load is displayed on the controller;
- When tested in dynamics, jack under test transfers load through the strain sensor to the press hydraulic cylinder, which moves and drains fluid through adjustment and safety valve, allowing to relieve the load from strain sensor in dynamics and to display it on the controller.

Model SDI100 operates in static and dynamic conditions. Model SDI150 operates in static conditions.

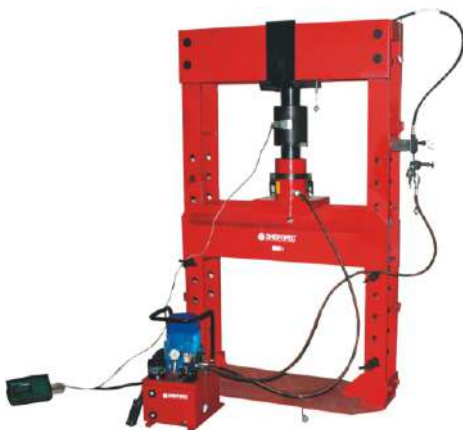

Model: PPK100SDI



Model: PPK150SDI

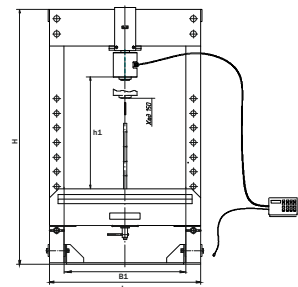

Model	Capacity, ton	Overall dimensions of operating space, mm (B1xh1)	Dimensions (BxLxH), mm	Weight, kg
PPK50SDI	50	600x1005	500x820x2005	386
PPK100SDI*	109,8	1000x890	495x1291x2085	745
PPK150SDI	150	1000x890	868x1693x1981	1203

* Model PPK100SDI completed pumping station NEI-1,6I10T1 (Pumping stations NEE ... I ..., page 88)

Hydraulic presses (horizontal)

Series PG., PPK...
Capacity — 200 ton
Pressure — 630 Bar



Model: PPK200G300G

— Designed to press-out and press-in tooth wheels, couplings, pulleys and drums of various devices used in gas and oil producing industry in conditions of maintenance works.

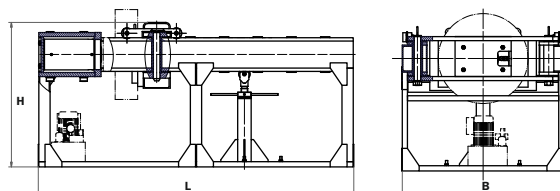

Model	Capacity, ton	Rod/cross arm stroke, mm	Overall dimensions of operating space, mm (B1xh1)	Dimensions (BxLxH), mm	Weight, kg	Recommended pump
PPK200G300G	200	300	1822x1000	1450x2810x1286	2285	NER..., NEE...

Hydraulic crimping presses

Series PN..., PNA...
Capacity — 7-200 ton
Crimping range — 16-700 mm²

Presses are designed for end bits, sleeves, and various tension, connecting, tap-off and flat clamps during installation of wires and cables of transmission lines and outdoor switchgears.
 — Models PNA are self-contained and have built-in pump;
 — Models PN are designed to operate from an external source of pressure (700 Bar);
 — Presses PN50M, PN100, PN200 are equipped with a safety valve that protects against overloads.



Model: PN200



Models: PN100, PN50M



Model: PNA12300

Model	Capacity, ton	Crimping range, mm ²	Crimping type	Hexagon dies, mm	Round dies, mm		Stroke, mm	Oil working capacity, cm ³	Dimensions (BxLxH), mm	Weight, kg	Recommended pump
					Aluminium muffs (series A)	Steel muffs (series B)					
PNA07120	7	16-120	☺	—	—	—	25	100	90x650x145	7,6	built-in
Pn07120	7	16-120		—	—	—	25	100	70x250x90	3,2	NRG-7004A
PNA12300	12	16-300		—	—	—	25	150	106x650x176	8,8	built-in
Pn12300	12	16-300		—	—	—	25	150	73x260x100	3,9	NRG-7004A
PN50M*	56	16-500	⊕ ⊙	13,8-50	18-56	15-42	35	275	161x264x349	18,9	NRG-7020R NER-1,6i10T1 NBR-1,2i8-1
Pn100*	100	50-700	⊕ ⊙	13,8-65	18-67	15-66	30	462	184x307x330	36	NRG-7020R NER-1,6i10T1 NBR-1,2i8-1
Pn200	202	64** 500**	⊕ ⊙	44,2-50,2	to 100	to 50	50	1417	380x341x608	210	NRG-7020R NER-1,6i10T1 NBR-1,2i8-1

* — presses of double action (it is recommended to equip with a manometer)

** — nominal cross section (aluminum / steel) mm²

*** — the sizes of matrices are picked up individually



Pumps p. 82



High pressure hoses
p. 107



Pressure gauges
p. 103



Dies for crimping table selection

Letters in the dies no:

A – for crimping of aluminium lugs and muffs

C – for crimping steel muffs

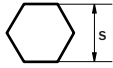
MSH – hexagon die for crimping aluminum, copper and steel muffs

Crimping type	Clamp	Wire	Model matrix	Press
	A2A,0A, A1, A4A, ZPS, SBS, RAS, ROA, A2AP, PPR, A1A	A, AS, PA, ASO, ASUS	MSHSPN50M, where S - before 50 mm MSHSPN100, where S - before 65 mm MSHSPN200, where S - before 50,2 mm	PN50M PN100 PN200
	NAS, SAS, PPT, PPR, AOA, 2A4A, 3A2A, 3A4A ZPS, PP, NS, A1M, A2M, A4M, SASUS NAS, SAS, PPT, PPR, AOA, 2A4A, 3A2A, 3A4A, NAP ZPS, PP, NS, A1M, A2M, A4M, SASUS NAS, SAS, PPT, PPR, AOA, 2A4A, 3A2A, 3A4A, NAP ZPS, PP, NS, A1M, A2M, A4M, SASUS	A, AS, ASU, ASO, ASUS, PA, M, PM, PS, B, BS, BSA	ADPN50M, where D - before 56 mm SDPN50M, where D - before 42 mm ADPN100, where D - before 67 mm SDPN100, where D - before 66 mm ADPN200, where D - before 100 mm SDPN200, where D - before 50 mm	PN50M PN100 PN200



In photo PN100 in operation

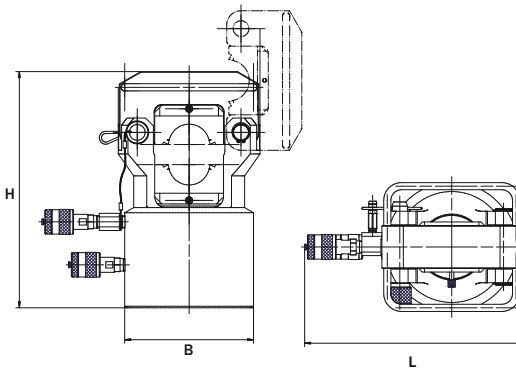

Overall dimensions of presses PN50, Pn100

Hydraulic Knockout Punch

Series PPL...

Capacity – 10 ton

Pressure – 700 Bar



Model: PPL15

Hydraulic knockout punch are designed for punching holes in sheet material with a diameter up to 114,7 mm with maximum accuracy. Hole punching takes minimal time. To bypass the traction stud you must first drill a hole.

The set includes a high-pressure hose 1 meter and manual pump - 0.4 liter.

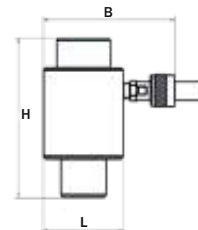

Model	Capacity, ton	Punching Dia, mm	Punching thickness, mm	Weight, kg
PPL10	10	21,9; 27,5; 34,2; 42,7; 48,3; 60,7	2,8-3,2	15
PPL15	10	21,9; 27,5; 34,2; 42,7; 48,3; 60,7; 76,5; 89,3; 101,9; 114,7	2,8-3,2	23

Hydraulic Punch

Series PP...

Capacity — 32-75 ton

Punching Diameter — 10-31 mm



Model: PP2416-07

- Designed to punch holes in the corners and channels with maximum accuracy;
- Allows you to significantly reduce the time of receipt of the hole compared to drilling.
- Time of punching a hole is 6 seconds;
- Open work area provides for easy installation and removal of workpieces;
- Double-acting hydraulic cylinder used in the design provides rapid performance of the cycle starting from hole punching to the punch return back to the starting position.

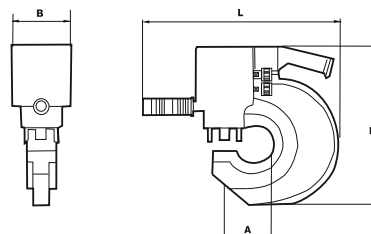

Model	Capacity, ton	Punching diameter, mm	Max. thickness, mm	Max. center depth, mm	Dimensions (BxLxH), mm	Weight, kg	Recommended pump
PP2410	32	10; 12; 14; 16	12	75	82x202x310	16,5	NEE-0,8G10T1
PP2416-07	45	16; 18; 20; 22; 24	16	75	114x350x322	25	
PP2416-11	45	16; 18; 20; 22; 24	16	110	113x429x330	32	
PP2420	60	18; 20; 22; 24	20	110	138x340x393	35	
PP3222	75	18; 20; 22; 24; 28; 31	20	110	180x578x419	75	

Press for mounting and dismounting of dump truck wheels KOMATSU-HD785

Series PRK...

Capacity — 100 ton

Stroke — 100-150 mm

Pressure — 700 Bar

Designed for mounting and dismounting of dump truck wheels KOMATSU-HD785.



Model: PRK 100

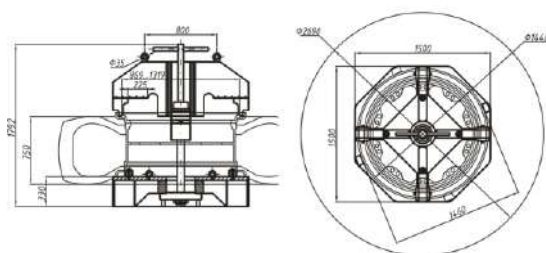

Model	Capacity, ton	Stroke, mm	Ambient temperature range, °C	Dimensions (BxLxH), mm	Weight, kg	Recommended pump
PRK100	100	150	-30 to +40	1500x1500x1792	1850	NEE-1,6I10T1

Hydraulic nut splitters

Series G...

Capacity — 6-56 ton

Nut range — 19-75 mm



Model: G2432, G1924, G2432, G3241, G4150, G5060

— Nut splitters ensure easy and safe removal of damaged or corroded nuts (one nut removal takes 2 minutes);
— They do not damage the surface of the threaded bolt or stud;

— Cylinder placed at an angle towards the work surface gives the opportunity to work with nuts, located not only on the flanges, but also nuts, located at a distance from the edge of a flat surface;

— Reliable design and ease of use.

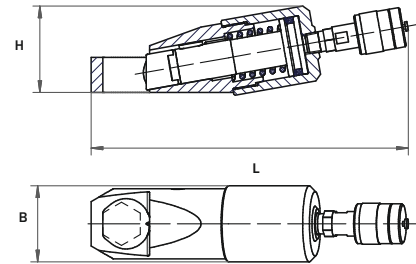

Model	Capacity, ton	Nuts		Stroke, mm	Dimensions (BxLxH), mm	Weight, kg	Recommended pump
		Nut range, mm	Range of threads				
G1019	6	10...19	M6...M12	15	45x227x63	1,7	NRG-7004A
G1924	10	19...24	M12...M16	15	55x247x68	2,5	NRG-7004A
G2432	14	24...32	M16...M24	22	65x271x76	3,5	NRG-7004A
G3241	20	32...41	M22...M27	23	80x300x90	5,1	NRG-7004A
G4150	23	41...50	M27...M36	23	85x309x92	5,3	NRG-7004A
G5060	35	50...60	M36...M42	27	102x343x113	9,3	NRG-7004A
G6075	56	60...75	M42...M48	35	130x387x195	20,5	NRG-7004A

Hydraulic cable cutters

Series NK..., NKA...

Capacity — 3 ton

Overcut cable diameter — 85 mm



Models: NK85, NKA85

The optimal choice for cutting of cable with aluminum and copper conductors, including armored and stranded wires of the same material, except cable and wire with steel core;
— Hinged bracket allows you to easily place the cable in the cutting zone;

— Model NKA85 is able to rotate the operating head to 360°.

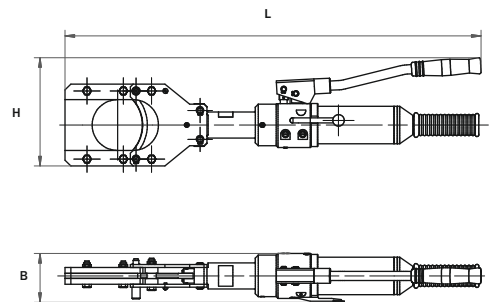

Model	Capacity, ton	Overcut cable diameter, mm	Stroke, mm	Dimensions (BxLxH), mm	Weight, kg	Recommended pump
NK85	3	85	90	70x464x142	6,2	NRG-7010
NKA85	3	85	90	98x721x187	8,5	built-in

Hydraulic general purpose cutters

Series NU..., NUA...
Capacity — 5-35 ton
Overcut diameter — 38 mm



Model: NUA16, NU16, NUA28A, Nu20

Designed to cut a wide range of materials: bars with square, round and hexagonal sections, fittings, aluminum and copper wire.

- Hinged bracket allows you to easily place the cable in the cutting zone;
- Models with built-in pumps have the ability to rotate the operating head to 360° which allows operation in the most remote places.
- Cutters NUA28A are designed to cut more durable material, with a hardness of up to 309 units Brinell and ultimate stress limit of up to 109 kg/mm².

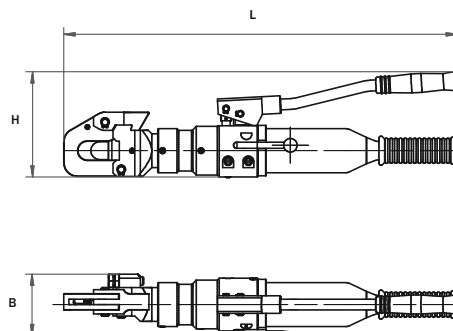

Model	Capacity, ton	Overcut diameter, mm		Mechanical properties of material being cut not more than:		Capacity on the handle, kgs	Dimensions (BxLxH), mm	Weight, kg	Recommended pump
		Steel	Aluminium/Copper	Brinell hardness units.	Tensile strength, kg/mm ²				
NU16	5	16	25/22	200	61	—	77,5x282x95	4	NRG-7004A
NU20	10	20	30	200	61	—	65x348x94,5	6,2	NRG-7004A
NU28	22,3	28	38	200	61	—	104x332x133	8,3	NRG-7004A, NRG-7010
NU28A	35	28	28	302	109	—	139x460x176	19,8	NRG-7010, NEE-0.8G10T1...
NUA16	5	16	25/22	200	61	20	91x582x156	7	built-in
NUA28	22,3	28	38	200	61	20	110x634x172	11,4	built-in
NUA28A	35	28	28	302	109	20	139x717x176	22,1	built-in

Hydraulic rope cutter

Series RT..., RTA...
Capacity — 22 ton
Overcut diameter — 50 mm



Model: RT50, RTA50

Designed for cutting steel ropes, hoses, with a maximum diameter of 50 mm and can be used during construction, installation and other types of work.

- Hinged bracket allows you to easily place the cable in the cutting zone;
- Spring stroke retraction to the starting position. Use of the product for cutting electric wires and cables under voltage is not allowed.

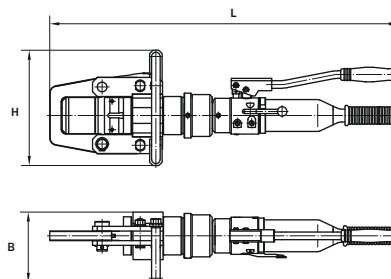

Model	Capacity, ton	Stroke, mm	Oil working capacity, cm ³	Overcut diameter, mm	Dimensions (BxLxH), mm	Weight, kg	Recommended pump
RT50	22	55	172	50	148x422x260	12,8	NRG-7010
RTA50	22	55	172	50	176x724x260	13,5	built-in

Corner cutters

Series NP..., NPA...
Capacity – 17,2-22,3 ton
Max. corner size – 75x75x7 mm



Model: NP50, NPA50

Cutters are designed for cutting rolled equilateral and nonequilateral angle steel during construction, installation, dismantling, repair and other work;
— Guillotine operating principle enables high-quality and clean cut;
— Hinged bracket allows you to easily place the cable in the cutting zone.

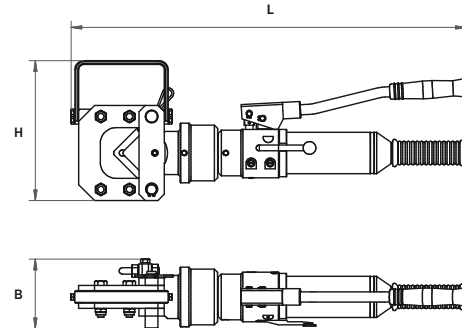

Model	Capacity, ton	Max. corner sizes, mm	Blade movement, mm	Dimensions (BxLxH), mm	Weight, kg	Recommended pump
NP50	22,3	50x50x6	25	110x308x221	8,7	NRG-7004A
NPA50	22,3	50x50x6	25	110x623x221	12	built-in
NPA75	17,2	75x75x7	65	181x767x221	15	built-in

Pipes and steel sheets cutters

Series NRT...
Overcut pipe – 70 mm
Cut length – 110 mm
Capacity – 20,2 ton



Model: NRT70

Cutters are designed for cutting pipes with wall thickness up to 3 mm and sheets of 5 mm thick and of no more than 150 mm wide. Cut material St3, Steel 20.

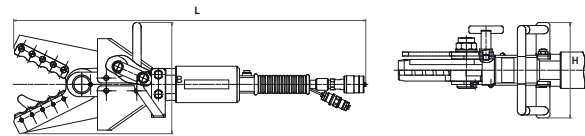

Model	Capacity, ton	Oil working capacity, cm ³	Overcut pipe diameter, mm	Cutting length, mm	Dimensions (BxLxH), mm	Weight, kg	Recommended pump
NRT70	20,2	152	70	110	194x661x226	12	NRG-7010

Hydraulic pistol cutters

Series NA...
Capacity – 2 ton



Model: NRT70

— Cutters effectively cut steel bars up to 8 mm, aluminum and copper wire with a diameter of 14 mm. High density construction of the model Na16 allows cutting trolley wires with a diameter of 16 mm.
— Can be used to remove the rope locking and seal devices of cars and containers. Cutters are indispensable when working in tight and fire dangerous spaces.
— The models have the ability to rotate the operating head to 360° which allows operation in the most remote places.

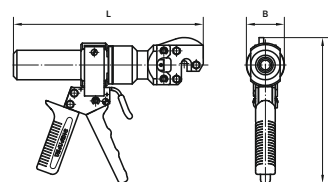

Model	Capacity, ton	Overcut diameter, mm			Capacity on the handle, kgf	Dimensions (BxLxH), mm	Weight, kg
		Steel	Aluminium/copper	Copper-clad steel conductor			
NA8	2	8	8	—	17	54x267x196	2,0
NA16	2	8	8/14	16	17	54x287x215	2,25

Hydraulic cassette torque wrenches

Series GKG...
Max. torque — 2420 kgm
Bolt sizes — 19-130 mm



Model: GKG500

Used when working in a confined space (flanged connections), when a stud or bolt is significantly above the nut. Cassettes can be easily installed and removed without the use of special tools. Upon request they are completed with a set of interchangeable heads according to the range of bolt sizes. Jointed radial working fluid intake lets you target high-pressure hose in the desired direction regardless of the pump position. When working with the NEA pumping station type (with built-in timing relay) the torque wrench may work automatically.

The retaining ring is included in the delivery.

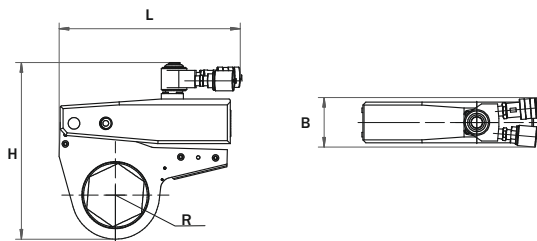

Model	Torque, max, kgm	Cassette model	Lowering inserts *, mm	Cassette radius R, mm	Dimensions with cassette, (BxLxH), mm	Weight with cassette, kg	Recommended pump		
GKG500	500	SB24500, 24 mm	21, 19	37	87x250x225	5,7	NEA		
		SB27500, 27 mm	24, 21, 19	37	87x250x225	5,8	NEA		
		SB30500, 30 mm	27, 24, 21, 19	40	87x250x228	6,1	NEA		
		SB36500, 36 mm	32, 30, 27, 24, 21, 19	40	87x250x228	6,0	NEA		
		SB41500, 41 mm	36, 32, 30, 27, 24, 21, 19	47	87x250x234	6,4	NEA		
		SB46500, 46 mm	41, 36, 32, 30, 27, 24, 21	47	87x250x234	6,3	NEA		
		SB50500, 50 mm	46, 41, 36, 32, 30, 27, 24	55	87x250x241	6,6	NEA		
		SB55500, 55 mm	50, 46, 41, 36, 32, 30, 27, 24	55	87x250x241	6,5	NEA		
		SB60500, 60 mm	55, 50, 46, 41, 36, 32, 30, 27	60	87x250x246	6,8	NEA		
		SB65500, 65 mm	60, 55, 50, 46, 41, 36, 32, 30	60	87x250x246	6,7	NEA		
		SB70500, 70 mm	65, 60, 55, 50, 46, 41, 36, 32	65	87x250x252	7,8	NEA		
		SB75500, 75 mm	70, 65, 60, 55, 50, 46, 41, 36	65	87x250x252	7,7	NEA		
		SB80500, 80 mm	75, 70, 65, 60, 55, 50, 46, 41	72	87x250x260	7,9	NEA		
		GKG1000	1000	SB501000, 50 mm	46, 41, 36, 32, 30, 27, 24	56	87x314x285	13,0	NEA
SB551000, 55 mm	50, 46, 41, 36, 32, 30, 27			56	87x314x285	12,9	NEA		
SB601000, 60 mm	55, 50, 46, 41, 36, 32, 30			60	87x314x287	13,3	NEA		
SB651000, 65 mm	60, 55, 50, 46, 41, 36, 32			60	87x314x287	13,2	NEA		
SB701000, 70 mm	65, 60, 55, 50, 46, 41, 36			70	87x314x297	13,5	NEA		
SB751000, 75 mm	70, 65, 60, 55, 50, 46, 41			70	87x314x297	13,4	NEA		
SB801000, 80 mm	75, 70, 65, 60, 55, 50, 46			72	87x314x299	13,6	NEA		
SB851000, 85 mm	80, 75, 70, 65, 60, 55, 50			72	87x314x299	13,5	NEA		
SB901000, 90 mm	85, 80, 75, 70, 65, 60, 55			76	87x314x303	13,7	NEA		
SB951000, 95 mm	90, 85, 80, 75, 70, 65, 60			76	87x314x303	13,6	NEA		
SB1001000, 100 mm	95, 90, 85, 80, 75, 70, 65			82,5	87x314x310	14,3	NEA		
SB1051000, 105 mm	100, 95, 90, 85, 80, 75, 70			90	87x314x320	14,5	NEA		
SB501500, 50 mm	46, 41, 36, 32, 30, 27, 24			56	87x314x285	13,0	NEA		
GKG1500	1500			SB551500, 55 mm	50, 46, 41, 36, 32, 30, 27	56	87x314x285	12,9	NEA
		SB601500, 60 mm	55, 50, 46, 41, 36, 32, 30	60	87x314x287	13,3	NEA		
		SB651500, 65 mm	60, 55, 50, 46, 41, 36, 32	60	87x314x287	13,2	NEA		
		SB701500, 70 mm	65, 60, 55, 50, 46, 41, 36	70	87x314x297	13,5	NEA		
		SB751500, 75 mm	70, 65, 60, 55, 50, 46, 41	70	87x314x297	13,4	NEA		
		SB801500, 80 mm	75, 70, 65, 60, 55, 50, 46	72	87x314x299	13,6	NEA		
		SB851500, 85 mm	80, 75, 70, 65, 60, 55, 50	72	87x314x299	13,5	NEA		
		SB901500, 90 mm	85, 80, 75, 70, 65, 60, 55	76	87x314x303	13,7	NEA		
		SB951500, 95 mm	90, 85, 80, 75, 70, 65, 60	76	87x314x303	13,6	NEA		
		SB1001500, 100 mm	95, 90, 85, 80, 75, 70, 65	82,5	87x314x310	14,3	NEA		
		SB1051500, 105 mm	100, 95, 90, 85, 80, 75, 70	90	87x314x320	14,5	NEA		
		GKG1800	1830	SB651800, 65 mm	60, 55	60	87x383x340	24,0	NEA
				SB701800, 70 mm	65, 60, 55	70	87x383x348	24,2	NEA
				SB751800, 75 mm	70, 65, 60, 55	70	87x383x348	24,1	NEA
SB801800, 80 mm	75, 70, 65, 60, 55			84	87x383x352	24,4	NEA		
SB851800, 85 mm	80, 75, 70, 65, 60, 55			84	87x383x352	24,3	NEA		
SB901800, 90 mm	85, 80, 75, 70, 65, 60			92	87x383x360	24,4	NEA		
SB951800, 95 mm	90, 85, 80, 75, 70, 65			92	87x383x360	24,5	NEA		
SB1001800, 100 mm	95, 90, 85, 80, 75, 70			94	87x383x362	24,6	NEA		
SB1051800, 105 mm	100, 95, 90, 85, 80, 75			94	87x383x362	24,5	NEA		
SB1101800, 110 mm	105, 100, 95, 90, 85, 80			102	87x383x370	24,8	NEA		
SB1151800, 115 mm	110, 105, 100, 95, 90, 85			102	87x383x370	24,7	NEA		
SB1301800, 130 mm	125, 120, 115, 110, 105, 100			106	87x383x374	24,9	NEA		
FKT2400	2420			SB652400, 65 mm	60, 55	60	87x383x340	24,0	NEA
				SB702400, 70 mm	65, 60, 55	70	87x383x348	24,2	NEA
		SB752400, 75 mm	70, 65, 60, 55	70	87x383x348	24,1	NEA		
		SB802400, 80 mm	75, 70, 65, 60, 55	84	87x383x352	24,4	NEA		
		SB852400, 85 mm	80, 75, 70, 65, 60, 55	84	87x383x352	24,3	NEA		
		SB902400, 90 mm	85, 80, 75, 70, 65, 60	92	87x383x360	24,4	NEA		
		SB952400, 95 mm	90, 85, 80, 75, 70, 65	92	87x383x360	24,5	NEA		
		SB1002400, 100 mm	95, 90, 85, 80, 75, 70	94	87x383x362	24,6	NEA		
		SB1052400, 105 mm	100, 95, 90, 85, 80, 75	94	87x383x362	24,5	NEA		
		SB1102400, 110 mm	105, 100, 95, 90, 85, 80	102	87x383x370	24,8	NEA		
		SB1152400, 115 mm	110, 105, 100, 95, 90, 85	102	87x383x370	24,7	NEA		
		SB1302400, 130 mm	125, 120, 115, 110, 105, 100	106	87x383x374	24,9	NEA		

All cassettes and inserts are equipped with locking rings

* For a schematic diagram for ordering lowering inserts, see page 40

For the order of lowering inserts it is necessary to use the following scheme:

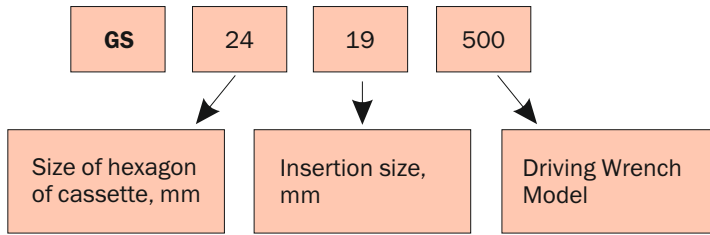

Cassette (SB series) with interchangeable inserts (HS series)

Hydraulic torque wrenches

Series GG...

Max. torque — 6000 kgm

Bolt sizes — 19-255 mm

Designed for screwing and unscrewing nuts, bolts and other fasteners. Quick change of square drive position provides change of the direction of rotation (screwing, unscrewing). The design of lightweight high-strength alloys ensures high power density. Mount support arm in the model GG400 rotating to 360°, allows quick and easy selecting of any position of the reference surface. Various sizes of coupling wrench heads. Jointed radial working fluid intake lets you target high-pressure hose in the desired direction. When working with the NEA pump type (with built-in timing relay) the torque wrench may work automatically.



Model: GG400

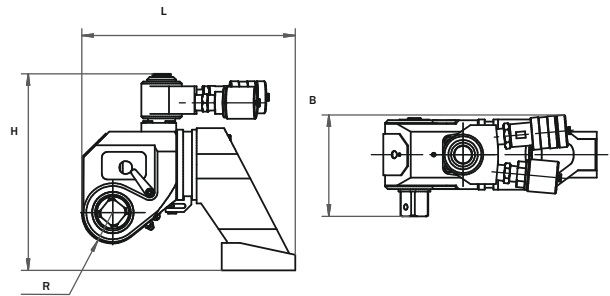

Model: GG1600T



Model IT400: number of positions of installation of the support lever - 32

Model	Torque, max, kgm	Landing size for replacement head, in.	Size of the replacement heads, mm	Size R, mm	Dimensions BxLxH	Weight, kg	Recommended pump
GG400	386	1	19-110	32	107x233x214	6,2	NEA
GG800T	827	1½(1,5)	27-150	40	137x361x189	11,2	NEA
GG1100T	1158	1½(1,5)	27-150	45	137x405x196	13,5	NEA
GG1600T	1602	1½(1,5)	27-150	48	168x421x201	15,2	NEA
GG2000T	2024	2	27-180	50	162x429x216	17,5	NEA
Gg2800T	2868	2	27-180	55	197x404x305	25,3	NEA
GG6000T	6000	2½(2,5)	50-255	71	232x514x305	49	NEA



Connecting the wrench, p.



Pump Selection Table page 82



Hydraulic accessories page 102

Impact sockets

Socket model	Flat-to-flat dimension, mm	Outer diameter of head, mm	Connection diameter of head, mm	Nut depth, mm	Pin depth, mm	Height of head, mm	Weight, kg
1"							
GS19-1	19	37	37	10	26	60	0,6
GS21-1	21	39		12			0,6
GS22-1	22	40		12			0,6
GS24-1	24	41		14			0,7
GS27-1	27	44		16			0,7
GS30-1	30	47		18			0,7
GS32-1	32	49		20	0,7		
GS36-1	36	54		22	0,7		
GS41-1	41	62		24	36	70	0,9
GS46-1	46	65		27	37	75	1,1
GS50-1	50	70		30	40	80	1,1
GS55-1	55	76		33	43	85	1,3
GS60-1	60	82		36	46	90	1,5
GS65-1	65	87		40	50	95	1,7
GS70-1	70	105		44	54	100	2,8
GS75-1	75	110		48	58	105	3,2
GS80-1	80	115		52	62	110	3,6
GS85-1	85	120		56	66	115	4,0
GS90-1	90	125	60	70	120	4,4	
GS95-1	95	130	64	74	125	4,8	
GS100-1	100	135	68	78	130	5,3	
GS105-1	105	140	72	82	135	5,8	
GS110-1	110	145	76	86	140	6,3	
GS()-1	to order	—	—	—	—	—	—
1 1/2"							
GS27-1,5	27	65	70	43,5	55	95	1,5
GS30-1,5	30	65		42	55	95	1,4
GS32-1,5	32	65		41	60	100	1,4
GS36-1,5	36	65		34	55	95	1,3
GS41-1,5	41	70		38	67	107	1,6
GS46-1,5	46	72		41	80	120	1,8
GS50-1,5	50	75		43	85	125	1,7
GS55-1,5	55	80		43	90	130	1,9
GS60-1,5	60	85		41	95	135	2,1
GS65-1,5	65	95		65	100	140	2,9
GS70-1,5	70	95		56	100	140	2,5
GS75-1,5	75	102		56	105	145	2,9
GS80-1,5	80	108		57	105	145	3,2
GS85-1,5	85	113		57	110	150	3,4
GS90-1,5	90	118		57	110	150	3,6
GS95-1,5	95	124		62,5	115	155	4,0
GS100-1,5	100	130		63	115	155	4,3
GS105-1,5	105	136		96,5	120	160	5,2
GS110-1,5	110	140		96,5	120	160	5,1
GS115-1,5	115	148		98	125	165	6,0
GS120-1,5	120	154		98,5	125	165	6,4
GS125-1,5	125	166		105	130	170	7,2
GS130-1,5	130	166		100	130	170	7,4
GS135-1,5	135	172		100	130	170	8,3
GS140-1,5	140	185	102,5	135	175	9,0	
GS145-1,5	145	185	100	135	175	9,2	
GS150-1,5	150	190	100	135	175	9,4	
GS()-1,5	to order	—	—	—	—	—	—
2"							
GS27-2	27	85	90	43	50	90	1,5
GS30-2	30	85		45	55	90	1,8
GS32-2	32	85		50,5	60	100	2,6
GS36-2	36	85		44	55	95	2,3
GS38-2	38	85		47,5	60	100	2,7
GS41-2	41	85		47	67	107	2,4
GS42-2	42	85		46	67	107	2,7
GS46-2	46	85		49,5	80	120	2,5
GS48-2	48	85		52,5	80	120	2,8
GS50-2	50	85		48	85	125	2,4
GS55-2	55	85		45,5	90	130	2,3
GS60-2	60	85		41	95	135	2,2
GS65-2	65	95		56	100	140	3,1
GS70-2	70	99		56	100	140	3,2
GS75-2	75	108		56	105	145	3,9

Socket model	Flat-to-flat dimension, mm	Outer diameter of head, mm	Connection diameter of head, mm	Nut depth, mm	Pin depth, mm	Height of head, mm	Weight, kg	
GS80-2	80	114	90	57	105	145	4,2	
GS85-2	85	123		57	110	150	5,1	
GS90-2	90	128		57	110	150	5,4	
GS95-2	95	134		62,5	115	155	5,9	
GS100-2	100	140		63	115	155	6,3	
GS105-2	105	146		96,5	120	160	7,3	
GS110-2	110	152		96,5	120	160	7,8	
GS115-2	115	158		98	125	165	8,4	
GS120-2	120	164		98,5	125	165	8,9	
GS125-2	125	170		100	125	165	9,4	
GS130-2	130	176		100	130	170	10	
GS135-2	135	182		100	130	170	11	
GS140-2	140	187		100	130	170	11,4	
GS145-2	145	193		100	135	175	12	
GS150-2	150	198		100	135	175	12,4	
GS155-2	155	204		106	138	178	13,1	
GS160-2	160	212		113	140	180	13,5	
GS165-2	165	218		118	145	185	14,6	
GS170-2	170	229		125,5	146	186	15,2	
GS175-2	175	233		129,5	149	189	15,4	
GS180-2	180	234		133	152	192	16,7	
GS()-2	to order	—		—	—	—	—	—
2 1/2"								
GS50-2,5	50	108		120	67	95	150	6,3
GS55-2,5	55	108	64,5		95	150	6,0	
GS60-2,5	60	108	63		97	152	5,9	
GS65-2,5	65	108	62		100	155	5,7	
GS70-2,5	70	108	62		100	155	5,9	
GS75-2,5	75	108	57		105	160	5,0	
GS80-2,5	80	110	57		105	160	5,2	
GS85-2,5	85	113	57		110	165	5,1	
GS90-2,5	90	122	59		110	165	5,6	
GS95-2,5	95	131	59		110	165	6,3	
GS100-2,5	100	144	63		115	170	9,0	
GS105-2,5	105	146	97		120	175	9,3	
GS110-2,5	110	146	97		120	175	9,8	
GS115-2,5	115	148	98		125	180	8,2	
GS120-2,5	120	156	95		125	180	9,2	
GS125-2,5	125	161	95		125	180	9,6	
GS130-2,5	130	167	100		125	180	10,2	
GS135-2,5	135	175	95		125	180	12,5	
GS140-2,5	140	195	90		110	165	15,1	
GS145-2,5	145	185	100		135	190	12,4	
GS150-2,5	150	210	100		115	170	18,3	
GS155-2,5	155	204	109		145	200	17,1	
GS160-2,5	160	220	105		125	180	20,4	
GS165-2,5	165	230	105		125	180	22,7	
GS170-2,5	170	235	110		130	185	23,7	
GS175-2,5	175	240	115		135	190	25,1	
GS180-2,5	180	245	115		135	190	25,7	
GS185-2,5	185	252	115		135	190	27,3	
GS190-2,5	190	260	120		140	195	29,7	
GS195-2,5	195	265	125		145	200	30,2	
GS200-2,5	200	270	130		150	205	33,0	
GS205-2,5	205	277	130		150	205	34,6	
GS210-2,5	210	285	130	150	205	36,9		
GS215-2,5	215	286	135	155	210	36,3		
GS220-2,5	220	292	140	160	215	38,6		
GS225-2,5	225	300	145	165	220	41,9		
GS230-2,5	230	308	150	170	225	45,6		
GS235-2,5	235	314	155	175	230	48,1		
GS240-2,5	240	320	160	180	235	51,9		
GS245-2,5	245	330	165	185	240	53,7		
GS250-2,5	250	335	170	190	245	58,5		
GS255-2,5	255	340	170	195	250	59,3		
GS()-2,5	to order	—	—	—	—	—	—	

Sockets not specified in Table may be manufactured with parameters necessary for the Customer

order placement (3952) 211-140, 8-800-100-78-18 Free call within Russia

Hydraulic Bolt Tensioners

Series DTG...
Capacity — 9-615 ton
Pressure — 600-700 Bar



Model: DTG600M

Model: DTG80

Designed for screwing and unscrewing nuts with calibrated capacity in heavy duty fasteners when performing installation and dismantling and repair work in all industry branches. The work of the bolt tensioner is based on pre-stretching of a stud (bolt) with a capacity equal to the required capacity of screw connection fastening and the subsequent tightening of nuts without the application of capacity against stop into the support surface. Bolt tensioner can be grouped and powered by a single pressure source through multi-way valves, which is the essential solution when you need to produce a synchronized tightening of the large number of bolted joints. Complete with removable holders and adapters according to the operating range.

Advantages of Bolt tensioners:

Most conventional tools and devices that are used to tighten screw connections when working with long bolts (studs) can cause them to twist and thus complicate the problems for which they were created. These are the offset flange leaks, damaged seals that cause unplanned downtime for troubleshooting.

In all cases, when tightening screw connections requires maximum accuracy, reliability and dosed torque, the best option is to use a hydraulic bolt tensioner that solves all these problems.

Bolt tensioner range of use: flanged pipe joints, heat exchangers, pressure vessels, rolling mills, presses, motors, crushers, diesel engines, valves, turbines, compressors, and more.

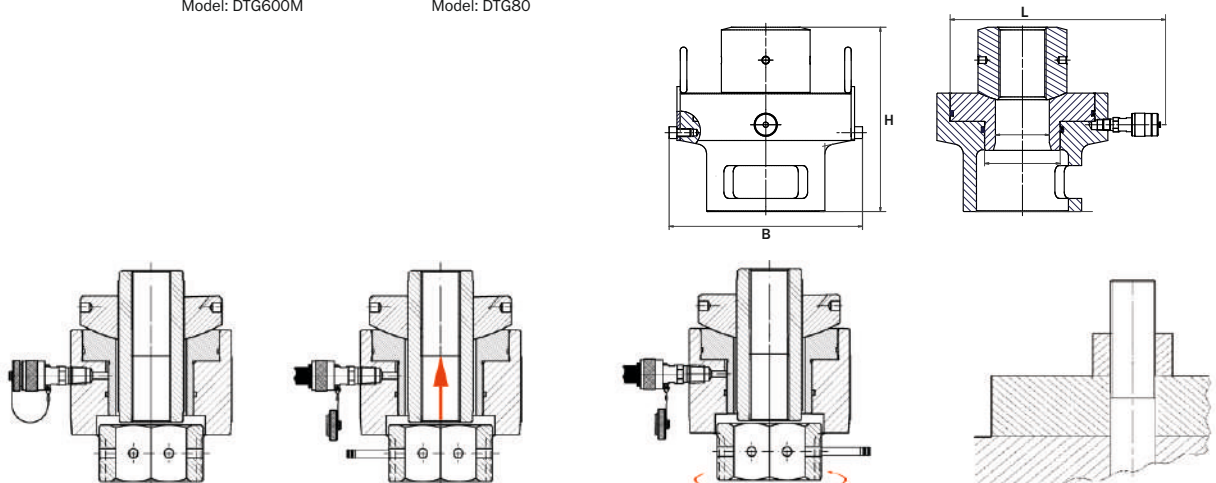

Nut is screwed by hand all the way into the supporting surface, and then the holder is set on the nut. Interchangeable adapter is screwed onto the exposed end of the stud. Length of adapter screwing with the stud must not be less than the diameter of the latter.

Pressure is applied to the cavity of the cylinder, and creates a capacity through which the stud is pulled.

Nut is screwed by hand all the way in without effort, and the pressure is released.

The cylinder is removed.

Model	Capacity, ton	Nominal pressure, Bar	Oil working capacity, cm ³	Nut range, mm	Size of thread, mm	Dimensions (BxLxH), mm	Weight, kg	Recommended pump
DTG10-24	9	70	10	36	M24x1,5	70x178,5x138	2,5	NRG-7004
DTG20	20	70	29	41, 46, 50	M27x2, M30x2, M33x2	104x184x165	8,8	NRG-7004
DTG30	29	70	40	55, 60, 65	M36x3, M39x3, M42x3	120x200x158	12,6	NRG-7004
DTG80	81,7	70	149	65, 95	M42x3, M64x4	190x270x212	31	NRG-7004
DTG85M	87	70	122,5	65, 75	M42, M48	142x233x436	20	NRG-7004
DTG125	125,5	60	246,2	круглая гайка	M52x3	254x300x280	33	NRG-7010
DTG200	197	70	552,2	круглая гайка	M72x4	294x338x280	45,6	NRG-7010
DTG600M	615	60	1043	150	M100x6	290x453x853	251	NRG-7020R

The company "Enerpred" accepts orders for the development and manufacture of hydraulic bolt tensioners on individual size and characteristics of the customer.

Mechanical torque wrenches



CONVENIENCE OF USE

Removable square drive with hinge mount. Guaranteed accuracy at any hand position.

RELIABILITY

Wear-resistant, rugged design. The initial level of accuracy + / - 3% is maintained for 10,000 operations.

SAFETY

The gradual increase of the torque to its set point is determined visually, by the sound and the capacity applied.

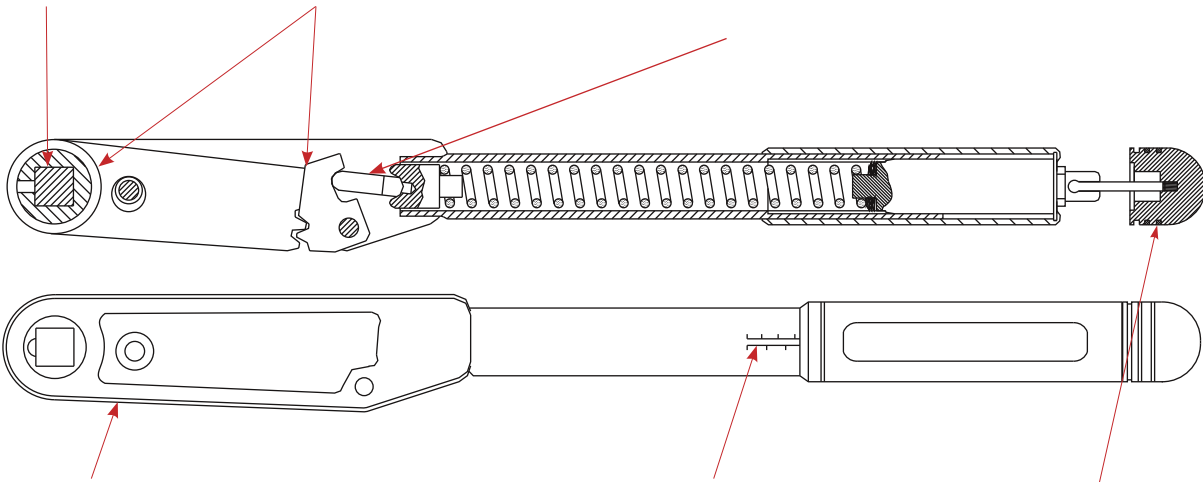

PORTABILITY

The width of the wrench head is not greater than the width of the impact head. The wrenches can be used in confined spaces.

ACCURATE TORQUE SETTING

Large, clear graduations on the torque scale. Units of measure: Nm, Kgm, lbf/in, lbf/ft.

CONVENIENCE OF USE

Fast and safe torque adjustment protected from accidental changes.

3/8" and 1/2" square drive

Model	Ratchet	Torque range				Square drive, inch	Length, mm	Weight, kg
		Nm	Kgm	Lbf/in	Lbf/ft			
PVT-100A	-	2,5-11	0,3-1,2	20-100	2-8	3/8	318	0,56
PVTR-100	+	2,5-11	0,3-1,2	20-100	2-8	3/8	334	0,65
PVT-300A	-	5-34	0,5-3,5	40-300	4-24	3/8	422	0,60
PVTR-300	+	5-34	0,5-3,5	40-300	4-24	3/8	443	0,75
PVTR-600	+	12-68	1,2-7	100-600	10-50	3/8	499	1,10
PVT-600A	-	12-68	1,2-7	100-600	10-50	1/2	476	1,02
PVT-1200A	-	25-135	3-14	200-1200	20-100	1/2	546	1,62
PVTR-1200	+	25-135	3-14	200-1200	20-100	1/2	555	2,00
PVT-2000A	-	50-225	5-23	400-2000	40-160	1/2	597	2,38
PVTR-2000	+	50-225	5-23	400-2000	40-160	1/2	626	2,49
PVT-3000A	-	70-330	7-35	600-3000	50-250	1/2	825	3,12
PVTR-3000	+	70-330	7-35	600-3000	50-250	1/2	840	4,00

3/4" and 1" square drive

Model	Ratchet	Torque range			Square drive, inch	Length, mm	Weight, kg
		Nm	Kgm	Lbf/ft			
PVT-5000	-	140-560	14-57	100-410	3/4	1130	5,90
PVTR-5000	+	140-560	14-57	100-410	3/4	1210	6,58
PVT-7200	-	200-810	22-82	150-600	3/4	1181	6,50
PVTR-7200	+	200-810	22-82	150-600	3/4	1261	7,00
PVT-8400	-	480-940	49-95	350-700	1	1397	11,30
PVTR-8400	+	480-940	49-95	350-700	1	1471	12,70
PVT-12300	-	700-1400	70-140	500-1000	1	1505	15,50
PVTR-12300	+	700-1400	70-140	500-1000	1	1505	17,00
TQW-10	-	1015-1900	105-195	750-1400	1	1356	16,50
TQW-R-10	+	1015-1900	105-195	750-1400	1	1356	18,00
TQW-11	-	1350-2700	135-275	1000-2000	1	1498	19,50
TQW-R-11	+	1350-2700	135-275	1000-2000	1	1498	20,60

Mechanical torque multipliers

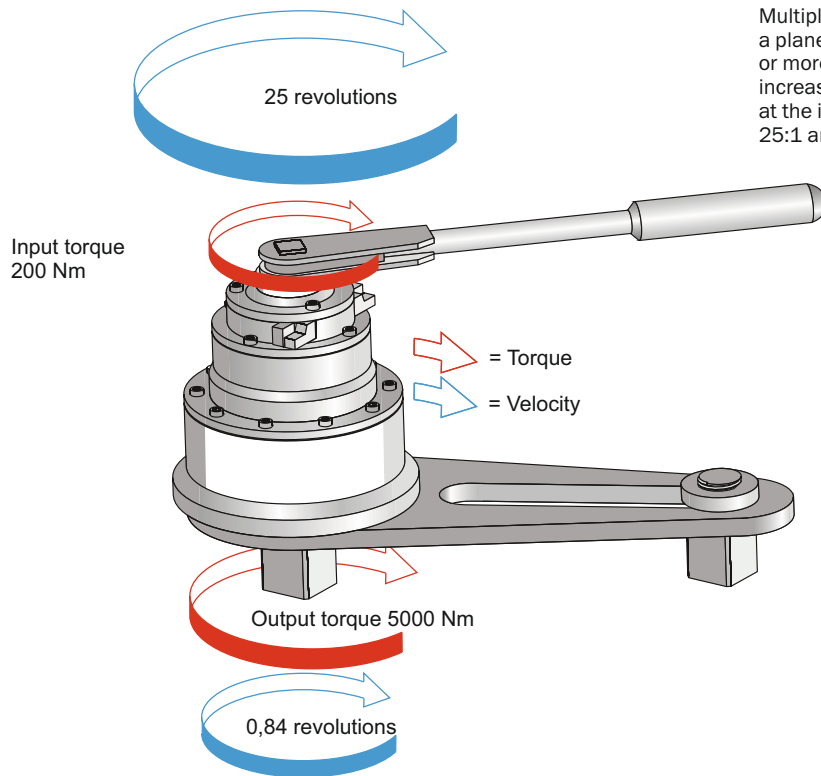

Multipliers with manual transmission have a planetary gear system, which can have one or more stages. Each step produces a five-fold increased torque developed by the operator at the input, providing the gear ratio of 5:1, 25:1 and 125:1.



In photo: PVTR-1200 and multiplier BTM-2/25

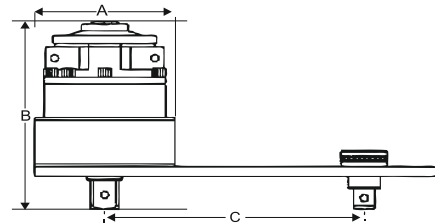

ADVANTAGES:

- Accuracy better than $\pm 4\%$.
- Precision tightening and loosening of all heavy duty fasteners.
- Low energy input with high torque transfer.
- Higher capacity multipliers are furnished with strong ratchets (Anti-wind up mechanism) allowing jobs to be performed easily, efficiently, and safely.
- Precision Manufacturing ensures long life and premier quality.
- A groove on output Square breaks if over loaded in excess of 20% of its capacity.
- Highest possible load factor is guaranteed due to design and use of forged components.

Model	Capacity		Gear ratio	Input square, inch	Output square, inch	A, mm	B, mm	C min, mm	C max, mm	Weight, kg
	Nm	Lbf/ft								
BTM-6	3400	2500	5	3/4	1 1/2	136	149	105	260	9,20
BTM-6/25	3400	2500	25	1/2	1 1/2	136	176	105	260	12,00
BTM-7	6000	4500	5	3/4	1 1/2	168	174	115	310	18,00
BTM-7/25 (AWUR)	6000	4500	25	3/4	1 1/2	168	226	115	310	22,00
BTM-9/25 (AWUR)	9500	7000	25	3/4	1 1/2	195	256	150	350	33,00
BTM-9/125 (AWUR)	9500	7000	125	1/2	1 1/2	195	301	150	350	35,50
BTM-11/25 (AWUR)	17000	12500	25	3/4	2 1/2	220	360	164	480	52,00
BTM-11/125 (AWUR)	17000	12500	125	1/2	2 1/2	220	404	164	480	57,00
BTM-13/125 (AWUR)	47500	35000	125	3/4	2 1/2	315	550	164	480	80,00

Straight slugging wrenches

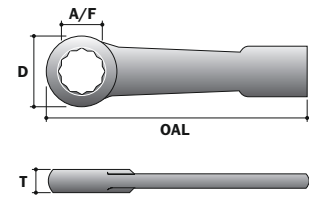

A/F Dimensions across flats
 D Maximum width of head
 T Maximum thickness of ring
 OAL Nominal overall length

Bihexagon



A / F, mm	Model	T, mm	D, mm	OAL, mm	Weight, kg.
22	MSW22	18.0	48.0	182.0	0.610
23	MSW23	18.0	48.0	182.0	0.610
24	MSW24	18.0	48.0	182.0	0.610
25	MSW25	18.0	48.0	182.0	0.590
26	MSW26	18.0	48.0	182.0	0.590
27	MSW27	18.0	48.0	182.0	0.590
28	MSW28	18.0	54.0	185.0	0.580
29	MSW29	18.0	54.0	185.0	0.560
30	MSW30	18.0	54.0	185.0	0.550
31	MSW31	18.0	54.0	185.0	0.540
32	MSW32	18.0	54.0	185.0	0.550
33	MSW33	18.0	54.0	185.0	0.540
34	MSW34	18.0	54.0	185.0	0.540
35	MSW35	18.0	54.0	185.0	0.540
36	MSW36	22.0	64.0	215.0	1.060
37	MSW37	22.0	64.0	215.0	1.060
38	MSW38	22.0	64.0	215.0	1.040
39	MSW39	22.0	64.0	215.0	1.030
40	MSW40	22.0	64.0	215.0	1.030
41	MSW41	22.0	64.0	215.0	1.030
42	MSW42	22.0	64.0	215.0	1.020
43	MSW43	25.0	76.0	238.0	1.480
44	MSW44	25.0	76.0	238.0	1.470
45	MSW45	25.0	76.0	238.0	1.430
46	MSW46	25.0	76.0	238.0	1.400
47	MSW47	25.0	76.0	238.0	1.380
48	MSW48	25.0	80.0	240.0	1.360
49	MSW49	25.0	80.0	240.0	1.350
50	MSW50	25.0	80.0	240.0	1.340
51	MSW51	25.0	80.0	240.0	1.400
52	MSW52	25.0	80.0	240.0	1.400
54	MSW54	25.0	80.0	240.0	2.350
55	MSW55	28.0	88.0	262.0	2.320
56	MSW56	28.0	88.0	262.0	2.325
57	MSW57	28.0	88.0	262.0	2.310
58	MSW58	28.0	88.0	262.0	2.300
59	MSW59	28.0	94.0	265.0	2.250
60	MSW60	28.0	94.0	265.0	2.140
61	MSW61	28.0	94.0	265.0	2.140
62	MSW62	28.0	94.0	265.0	2.500
65	MSW65	30.0	104.0	285.0	2.710
67	MSW67	30.0	104.0	285.0	2.770
70	MSW70	35.0	110.0	315.0	3.410
73	MSW73	35.0	110.0	315.0	3.410
75	MSW75	35.0	110.0	315.0	3.400

A / F, mm	Model	T, mm	D, mm	OAL, mm	Weight, kg.
76	MSW76	35.0	110.0	315.0	3.370
80	MSW80	38.0	126.0	340.0	4.860
85	MSW85	38.0	126.0	340.0	4.400
86	MSW86	38.0	126.0	340.0	4.300
90	MSW90	42.0	152.0	400.0	4.650
95	MSW95	42.0	152.0	400.0	4.360
100	MSW100	42.0	152.0	400.0	7.490
105	MSW105	50.0	172.0	410.0	10.580
110	MSW110	50.0	172.0	435.0	11.670
115	MSW115	50.0	172.0	435.0	10.760
120	MSW120	56.0	194.0	475.0	16.070
125	MSW125	56.0	194.0	475.0	16.960
130	MSW130	60.0	205.0	505.0	16.850
135	MSW135	60.0	205.0	510.0	16.550
140	MSW140	65.0	230.0	565.0	19.000
145	MSW145	65.0	230.0	565.0	18.810
150	MSW150	65.0	230.0	565.0	18.550
155	MSW155	65.0	230.0	565.0	18.350
160	MSW160	70.0	270.0	635.0	29.900
165	MSW165	70.0	270.0	635.0	29.700
170	MSW170	70.0	270.0	635.0	29.250
175	MSW175	70.0	270.0	635.0	28.850
180	MSW180	70.0	270.0	635.0	28.500
185	MSW185	75.0	295.0	680.0	35.600
190	MSW190	75.0	295.0	680.0	35.400
195	MSW195	75.0	295.0	680.0	35.200
200	MSW200	75.0	295.0	680.0	34.900
205	MSW205	75.0	295.0	680.0	34.700
210	MSW210	80.0	325.0	725.0	50.850
215	MSW215	80.0	325.0	725.0	50.550
220	MSW220	80.0	325.0	725.0	50.100
225	MSW225	80.0	325.0	725.0	49.800
230	MSW230	80.0	325.0	725.0	49.500

Offset slugging wrenches

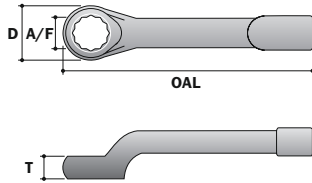

A/F Dimensions across flats
 D Maximum width of head
 T Maximum thickness of ring
 OAL Nominal overall length

Open-jaw slugging wrenches

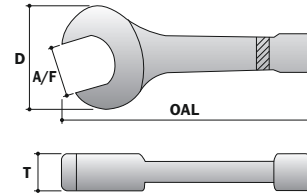

A/F Dimensions across flats
 D Maximum width of head
 T Maximum thickness of ring
 OAL Nominal overall length

Bihexagon



A / F, mm	Model	T, mm	D, mm	OAL, mm	Weight, kg.
24	MOSW24	20.0	42.0	250.0	1.000
27	MOSW27	25.0	52.0	270.0	1.060
30	MOSW30	25.0	52.0	270.0	1.150
32	MOSW32	25.0	52.0	270.0	1.290
34	MOSW34	25.0	52.0	270.0	1.640
35	MOSW35	32.0	68.0	312.0	1.550
36	MOSW36	32.0	68.0	312.0	1.500
38	MOSW38	32.0	68.0	312.0	1.750
40	MOSW40	32.0	68.0	312.0	1.950
41	MOSW41	32.0	68.0	312.0	2.150
43	MOSW43	35.0	82.0	340.0	2.850
46	MOSW46	35.0	82.0	340.0	2.630
47	MOSW47	35.0	82.0	340.0	2.610
48	MOSW48	35.0	82.0	340.0	2.600
49	MOSW49	35.0	82.0	340.0	2.450
50	MOSW50	35.0	82.0	340.0	2.350
51	MOSW51	35.0	82.0	340.0	3.190
52	MOSW52	38.0	82.0	360.0	3.000
54	MOSW54	38.0	82.0	360.0	3.000
55	MOSW55	38.0	82.0	360.0	2.930
56	MOSW56	38.0	82.0	360.0	2.980
57	MOSW57	38.0	82.0	360.0	4.850
58	MOSW58	38.0	82.0	360.0	4.750
59	MOSW59	38.0	82.0	360.0	4.900
60	MOSW60	44.0	110.0	380.0	4.430
61	MOSW61	44.0	110.0	380.0	4.350
62	MOSW62	44.0	110.0	380.0	4.300
65	MOSW65	44.0	110.0	380.0	5.650
67	MOSW67	44.0	110.0	380.0	5.500
70	MOSW70	50.0	127.0	400.0	7.320
73	MOSW73	50.0	127.0	400.0	7.000
75	MOSW75	50.0	127.0	400.0	6.880
76	MOSW76	50.0	127.0	400.0	6.750
80	MOSW80	50.0	127.0	400.0	8.630
85	MOSW85	50.0	127.0	400.0	7.480
86	MOSW86	57.0	152.0	465.0	9.100
90	MOSW90	57.0	152.0	465.0	8.970
95	MOSW95	57.0	152.0	465.0	11.680
100	MOSW100	57.0	152.0	465.0	11.470
105	MOSW105	63.5	194.0	540.0	12.000
110	MOSW110	63.5	194.0	540.0	11.740
115	MOSW115	63.5	194.0	540.0	11.710
120	MOSW120	63.5	194.0	540.0	11.550
125	MOSW125	63.5	194.0	540.0	11.250
130	MOSW130	63.5	194.0	540.0	11.050

A / F, mm	Model	T, mm	D, mm	OAL, mm
24	MOJ24	17	58	175
27	MOJ27	17	58	175
30	MOJ30	18	66	190
32	MOJ32	18	66	190
34	MOJ34	18	73	200
36	MOJ36	20	78	205
38	MOJ38	20	90	225
41	MOJ41	20	90	225
46	MOJ46	22	100	245
50	MOJ50	22	110	270
55	MOJ55	25	120	300
60	MOJ60	25	130	310
65	MOJ65	30	142	340
70	MOJ70	32	156	370
75	MOJ75	32	164	370
80	MOJ80	35	175	395
85	MOJ85	35	175	395
90	MOJ90	40	197	440
95	MOJ95	40	197	440
100	MOJ100	48	230	480
105	MOJ105	48	230	480
110	MOJ110	50	238	505
115	MOJ115	56	250	505
120	MOJ120	56	258	530
130	MOJ130	56	278	560
135	MOJ135	56	278	560
145	MOJ145	62	308	630
150	MOJ150	62	308	630
155	MOJ155	62	308	630
165	MOJ165	70	345	705
170	MOJ170	70	345	705
175	MOJ175	70	345	705
180	MOJ180	70	345	705
200	MOJ200	75	405	760
215	MOJ215	80	425	830
230	MOJ230	80	475	830

Spring balancers



Series SWF



Series SWA



Series SBH

- Spring balancers are used on assembly lines, for hanging hand tools, welding gun, machine for sewing bags, measuring instruments, control panels, etc.
- Spring balancers are designed to reduce the physical effort of the operator when working with hand tools. With properly adjusted spring tension, the tool will become almost weightless in the hands of the operator, and it can be raised and lowered with minimal effort.
- When choosing a balancer, it is first necessary to calculate the total weight of the equipment (tools, plus cable or hose, plus accessories). After you have determined the total weight, you need to install the spring tension (weight range).
- For maximum performance and durability, the balancer must be fixed directly above the work place, and perpendicular to the floor. With the constant need to move the balancer with a tool from one location to another, use undercarriage of the series I-Beam.

Series SWF:

Balancers in this series are produced in a closed housing and provided with a nylon guide cap.

Series SWA:

Spring balancers in this series have a cable locking mechanism that closes the drum, in the event of the weight falling. SWA series balancers are used when working with welding tongs, in conditions where the cable is likely to be damaged and the manual tools to be fallen. Spring Balancers up to 300 kg. Cable movement up to 3 meters.

Series SBH:

Spring Balancers up to 300 kg. Cable movement up to 3 meters.

	Capacity, ton	Model	Travel, m	Weight, kg	Capacity, kg	Model	Travel, m	Weight, kg
SWF	0.5 - 1.5	SWF - 01	1.0	1.0	-	-	-	-
	1.0 - 2.0	SWF - 02	1.0	1.0	-	-	-	-
	1.5 - 3.0	SWF - 03	1.3	1.8	1.5 - 3.0	SWF - 03L	2.5	4.2
	3.0 - 5.0	SWF - 05	1.3	1.9	3.0 - 5.0	SWF - 05L	2.5	4.4
	4.5 - 9.0	SWF - 09	1.3	4.0	4.5 - 9.0	SWF - 09L	2.3	8.0
	9.0 - 15.0	SWF - 15	1.3	4.0	9.0 - 15.0	SWF - 15L	2.3	8.0
	15.0 - 22.0	SWF - 22	1.5	8.0	15.0 - 22.0	SWF - 22L	2.3	8.5
	22.0 - 30.0	SWF - 30	1.5	9.0	22.0 - 30.0	SWF - 30L	2.3	9.5
	30.0 - 40.0	SWF - 40	1.5	10.5	30.0 - 40.0	SWF - 40L	2.3	11.0
	40.0 - 50.0	SWF - 50	1.5	11.0	40.0 - 50.0	SWF - 50L	2.3	12.0
	50.0 - 60.0	SWF - 60	1.5	12.0	50.0 - 60.0	SWF - 60L	2.3	13.0
	60.0 - 70.0	SWF - 70	1.5	12.5	60.0 - 70.0	SWF - 70L	2.3	13.5
	70.0 - 85.0	SWF - 85	1.5	13.0	70.0 - 85.0	SWF - 85L	2.5	18.0
	85.0 - 100.0	SWF - 100	1.5	13.5	85.0 - 100.0	SWF - 100L	2.5	28.0
	100.0 - 120.0	SWF - 120	1.5	29.0	100.0 - 120.0	SWF - 120L	2.5	29.0
	120.0 - 140.0	SWF - 140	1.5	31.0	110.0 - 130.0	SWF - 130L	2.5	31.0
	140.0 - 170.0	SWF - 170	1.5	35.0	-	-	-	-
170.0 - 200.0	SWF - 200	1.5	36.0	-	-	-	-	
SWA	9.0 - 15.0	SWA - 15	1.5	6.0	9.0 - 15.0	SWA - 15L	2.3	9.0
	15.0 - 22.0	SWA - 22	1.5	9.5	15.0 - 22.0	SWA - 22L	2.3	10.0
	22.0 - 30.0	SWA - 30	1.5	10.0	22.0 - 30.0	SWA - 30L	2.3	11.0
	30.0 - 40.0	SWA - 40	1.5	12.5	30.0 - 40.0	SWA - 40L	2.3	14.5
	40.0 - 50.0	SWA - 50	1.5	13.0	40.0 - 50.0	SWA - 50L	2.3	15.0
	50.0 - 60.0	SWA - 60	1.5	13.5	50.0 - 60.0	SWA - 60L	2.3	16.0
	60.0 - 70.0	SWA - 70	1.5	14.0	60.0 - 70.0	SWA - 70L	2.3	16.5
SBH	220.0 - 225.0	SBH - 225	1.5	48.0	85.0 - 100.0	SBH - 100	3.0	32.0
	225.0 - 250.0	SBH - 250	1.5	50.0	100 - 120.0	SBH - 120	3.0	42.0
	250.0 - 275.0	SBH - 275	1.5	52.0	120.0 - 140.0	SBH - 140	2.5	2.0
	275.0 - 300.0	SBH - 300	1.5	56.0	140.0 - 160.0	SWF - 05L	2.5	2.1

Hydraulic systems for moving heavy equipment on rails

Series UG...
Capacity – 10-50 ton
Stroke – 400-1000 mm
Pressure – 320 Bar

The system for moving heavy equipment on rails is indispensable for moving power transformers in substations, cars, locomotives, as well as construction and lifting equipment, etc., while installing, repairing and performing emergency repair and construction works. Designed by the construction department of CJSC "Enerpred" technology provides even moving of heavy objects by a unique system (patented in RF) of arms seizure on the rail head, even in conditions of placing the pushed object "uphill" (tilted)

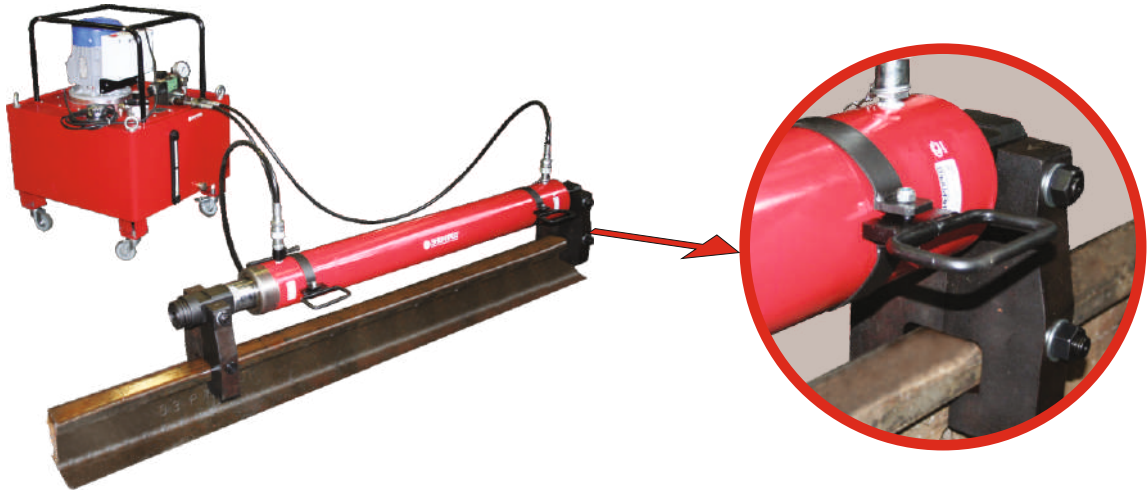

Model	Capacity, ton	Stroke, mm	Pushed object weight, ton		Type rail	Oil working capacity, cm ³	Dimensions (BxLxH), mm	Weight, kg	Distance from the rail head to the cylinder axis, mm	Recommended pump
			without wheels (Fw=0,15)	on wheels (Fw=0,05)						
UG10-2	10*2	500	65*2	200*2	R65	1560*2	909x284x349	46*2	120	NEE32-2,8ADD20T1
UG10-2R50	10*2	500	65*2	200*2	R50	1560*2	909x284x349	46*2	150	NEE32-2,8ADD20T1
UG25-2	25*2	1000	160*2	500*2	R65	7854*2	1483x332x412	146*2	150	NEE32-6ADD40T1
UG25/400-2	25*2	400	160*2	500*2	R65	3142*2	883x332x412	97*2	150	NEE32-2,8ADD40T1

* Width of one part



Model UG10-2 in operation

Model	Nominal pressure, Bar	Pump flow at rated speed of the electric motor drive shaft, l/min	Working fluid	Oil tank useful volume, l	Ambient temperature, °C	Pump drive	Dimensions (BxLxH), mm	Weight, kg
NEE32-2,8ADD20T1	320	2,8	Hydraulic Oils season: VMGZ TU 38, 101479-86; MGE-10A OST 38.01281-82	20	От -20 до + 60	Three phase asynchronous electric motor 5AIR80V2U3 (N _e =2,2kW; p=28 50 rpm; U=380 V/50Hz; IP54)	315x410x630	46
NEE32-2,8ADD40T1		2,8		40			540x570x800	75
NEE32-6ADD40T1		6,0		40		540x570x850	85	

Equipment for lifting mining excavators (KOP4-100)

Series KOP...
Stroke — 1600 mm



Model: KOP4-100



Set of lifting tools KOP4-100 is a complex solution for repair and maintenance of quarry equipment. It is designed for lifting quarry platforms of excavators, during scheduled and emergency repairs at the cuts in extractive industries. The development is patented and possesses permission to use at hazardous production facilities granted by Federal Service for Environmental, Technological, and Nuclear Supervision. These documents allow active implementation and use of the equipment at the plants. The development has already passed tests; now it is used by large extractive enterprises of Russia

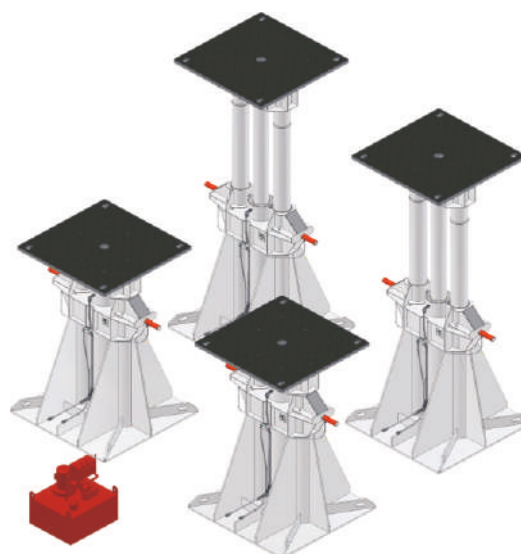

The set consists of 4 lifting mechanisms equipped with hydraulic locks, safety valves connected with pump station and hydraulic fixing device in end positions. Lifting of excavator rotating platform is provided by simultaneous operation of all 4 lifting mechanisms.

The set is designed for lifting of rotating platforms of quarry excavators of the following types.....EKG-5A, EKG-8I, EKG-10

Lifter height, mm.....	2600
Total lift height, mm.....	4200
Total load capacity of set, ton.....	400
Maximum lift, mm.....	1600
Weight of set, total, kg.....	17200

The following items are included in delivery set:

Lifter with foundation of 1600x1600, pcs.....	4
Pump station NER35-10A250T1-BU4-Pue50.....	1
High pressure hose with halfcouplings HPH115000, pcs.....	8
SPTA set, sets.....	1



NER35-10A250T1-BU4-Pue50

Parameters	Values
Pump station NER35-10A250T1-BU4-Pue50	
Rated pressure, MPa (kgf/cm ²)	35 (357)
Tank volume, L	250
Operating fluid	VMG3 TU38 101479-00 MGE-10A OST 38 01281-82
Range of ambient temperatures, °C	from -30 to +40
Remote control	24 V BUS4
Ov. dimensions, BxLxH	1000x640x1500
Weight, kg	250
Lifter with foundation of 1600 x 1600 mm	
Rated load capacity, ton	100
Piston stroke, mm	1600
Ov. dimensions, mm	1600x1600x2600
Weight, kg	3800

Equipment for lifting mine dump trucks (KOP1-50)

Series KOP...
Lift height – 500 mm



Set of equipment for lifting mine dump trucks KOMATSU HD785 is designed for lifting dump trucks under assembly while setting wheels and for lowering dump trucks on the wheels on the site of assembly.

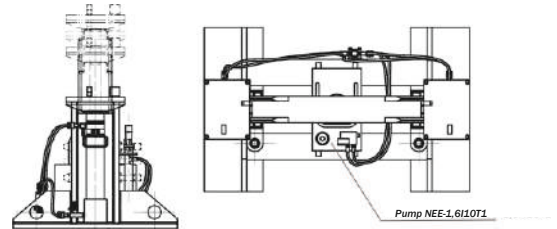

Recommended pump NEE-1,6I10T1

Lifter type	Capacity, ton	Lift height, mm	Lift time, mm	Fixing at height by pins, mm	Dimensions (BxLxH), mm	Weight, kg
Cylinder	51,2	500	3	300, 400, 500	1000x1620x860	894

Equipment for lifting mine dump trucks during the assembly work on the assembly site (KOP2-50)

Series KOP...
Stroke – 800 mm



Set of equipment is designed for lifting dump trucks while setting wheels and lowering dump trucks on the wheels of mine dump truck assembly.

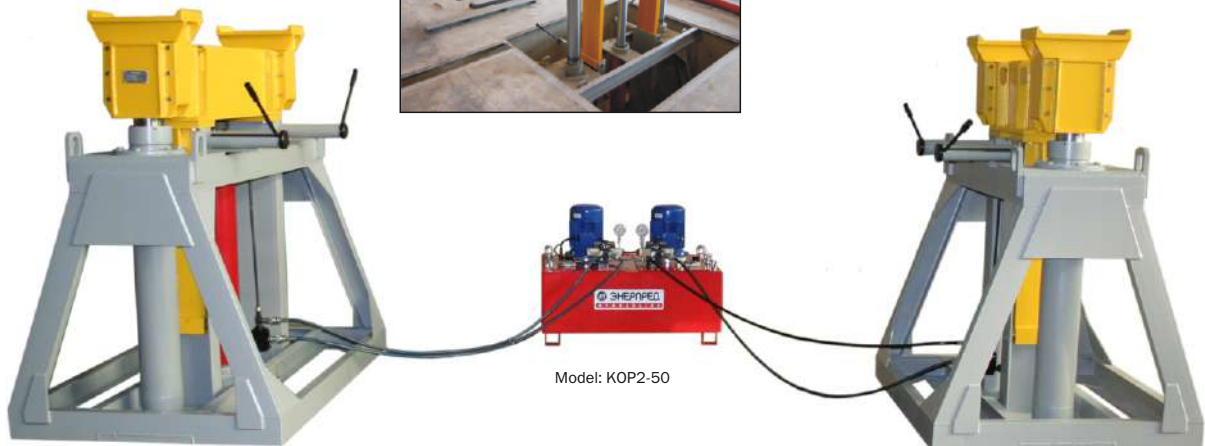

Model: KOP2-50

Lifter type	Capacity, ton	Stroke, mm	Dimensions (BxLxH), mm	Weight, kg
Lifter with the base 1150x1216 mm	49,2	800	1150x1216x1712	1360
Lifter with the base 1150x1746 mm	49,2	800	1150x1746x1712	1530

Pump	Flow, l/min	Nominal pressure, Bar	Tank volume, l	Range of ambient temperatures, °C	Dimensions (BxLxH), mm	Weight, kg
2NEE32-6I160T1-M2F	2x6	31.4	160	от -30 до +40	640x1020x750	180

Equipment for trenchless pipe-laying (UG600T)

Series UG...T

Puncture length — up to 200 m

Pressure — 700 Bar

UG600T – is designed for trenchless laying of pipelines under highways, railway embankments, in urban areas. It provides high speed and efficiency of work performing.

System compounds, set and characteristics may vary depending on customer requirements.

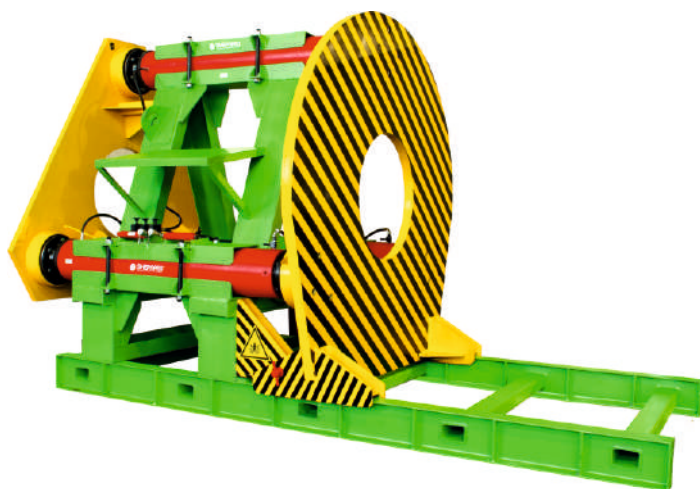

Installing UG600T with base plate

Model	Nominal capacity, ton	Stroke, mm	Nominal pressure, Bar	Puncture length, m	Ground categories	Diameter of the tube is pushed GOST mm	Dimensions (BxLxH), mm	Weight, kg	Mass installation with plate, t
UG600T	600	1250	630	до 200	I, II, III	630-2200	2045x3405x2335	1,9	4,2

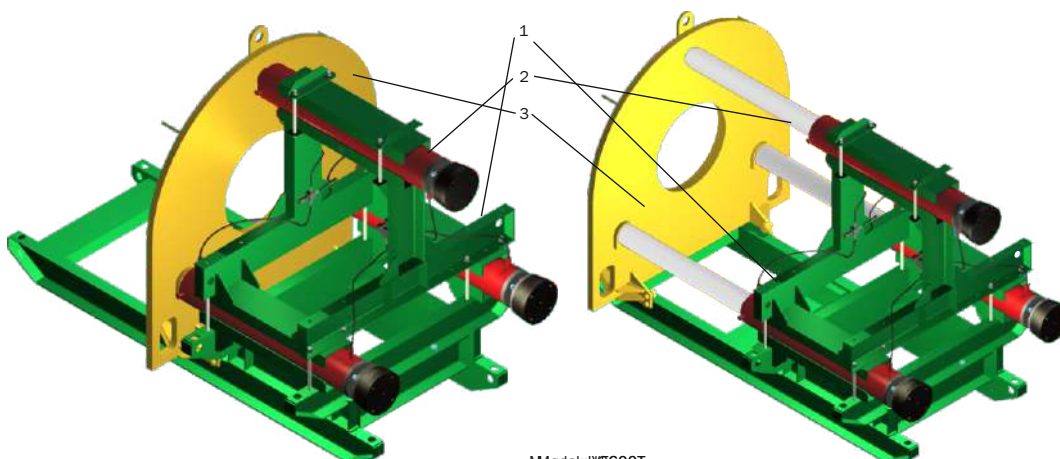

Model: UG600T

- 1 - Frame;
- 2 - Working hydraulic cylinders;
- 3 - Base plate.

Working sequence:

- Punching ground to a depth of the stroke action;
- Return of hydraulic cylinders to the starting position;
- Ground removal out of the pipe;
- Add of remote changeable inserts;



Model: UG600T in operation

Equipment for trenchless pipe-laying (UG100T)

Series UG. . .T
Puncture length — up to 50 m
Pressure — 700 Bar

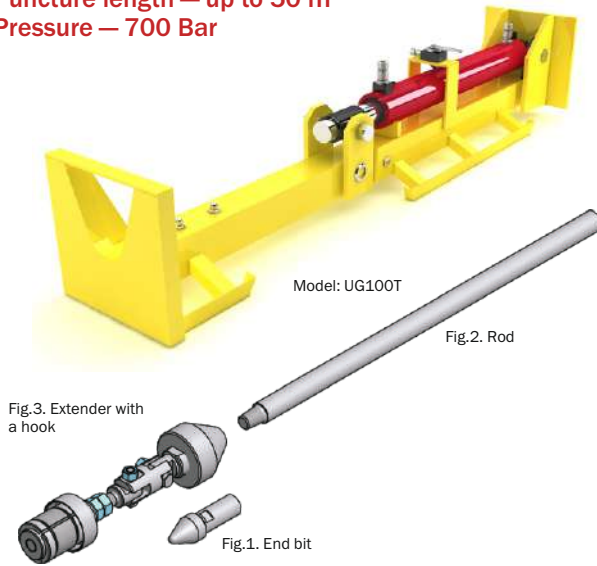

UG100T - designed for trenchless laying of different types of underground utilities (water, sewer, electric cable, etc.) by a puncture in the soil of the 1-3 categories under roads, tram tracks, railway embankments, marshy soils, forests, etc. with subsequent cable or polyethylene pipe or metal pipe pulling.

The set includes the end bit. Additionally the system includes extenders with hooks and rods. On customer request their characteristics (depending on the diameter of the pushed pipe and soil properties) and amount may vary.

	Diameter, mm	Weight, kg
End bit	60	21
Rod (length 1 m)	48	14
Extenders	130	8,5
	180	13,2
	270	33
Hook (pipe D110 mm)	120	12
Hook (pipe D160 mm)	170	21,2

Model	Capacity, ton	Pull capacity, ton	Stroke, mm	Nominal pressure, Bar	Puncture length, m	Ground categories	Dimensions (BxLxH), mm	Weight, kg
UG100T	100	50	1100	700	up to 50	I-III	500x2360x660	750

Phases and sequence of the pipe-laying:

PUNCTURE

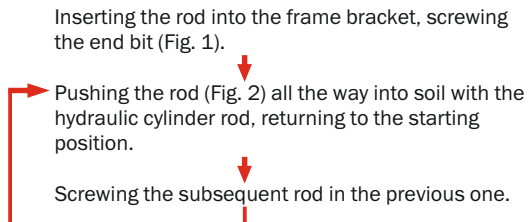

WIDENING OF CHANNELS

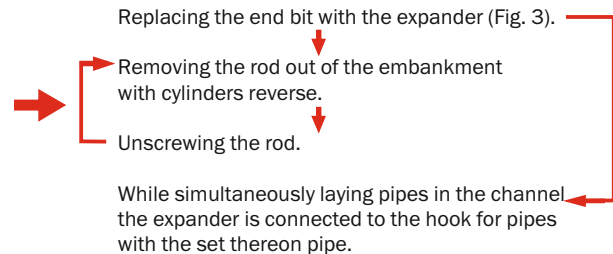

	Recommended pump	Puncture cycle (forward/back) 1 meter embankment*
gasoline	NBR-2,4I40-1	7 min./3 min. 30 sec.
	NBR-5,0I40-1	3 min. 30 sec./1 min. 40 sec.
	NBR-10,0I100-1	1 min. 45 sec./50 sec.
electric	NER-2,8I40T1	6 min. 10 sec./3 min.
	NER-5,0I40T1	3 min. 30 sec./1 min. 40 sec.
	NER-10,0I40T1	1 min. 45 sec./50 sec.

System compounds, recommended set and characteristics may vary depending on the requirements and wishes of the customer.

* Estimated time does not include preparation and final works, replacement of the rods



Model: UG100T in operation

Hydraulic framed modular systems for ground cutoff (UGRM)

Series UGRM...

Length of cutoff – up to 90 m

Pressure – 700 Bar



Model UGRM800 with diesel station NDR-18P160-1-Ku4B4

UGRM systems are simplified versions of systems for trenchless laying of pipes with large diameters under roads using ground punching. Systems are completed at the manufacturer or on-site in pit of one or several quick-assembly frame modules. Two, three, or four power hydraulic cylinders TsS200G1250Sh equipped with compensatory ball bearings of increased diameters on housings and rods are installed on these modules depending on diameter of pipes, length of punching and category of ground.

At option of the Customer, UGRM systems may be supplied with pump stations with electric, petrol, and diesel motors with power from 7.5 to 30 kW and flow rates from 6 to 25 L/min (single-stage) and up to 32 L/min (double-stage) at maximum pressure up to 700 Bar depending on required travel speed. Use of pump stations with flow rates of more than 10 L/min allows significant increase in work output.

Recommended stations for:

UGRM400: NER-10P100T1-Ku02B2; NEE-10AKK100T1; NBR-10P100-1-Ku02B2; NDR-10P160-1-Ku02B2.

UGRM600: NER-18P160T1-Ku3B3; NEE-18AK3K160T1; NBR22/70-32/9P160-2-Ku3B3; NDR-18P160-1-Ku3B3.

UGRM800: NER-25P200T1-Ku4B4; NEE-25AK4K200T1; NBR22/70-32/9P160-2-Ku4B4; NDR-18P160-1-Ku4B4.

Model	Rated capacity, ton	Rod stroke, mm	Rated pressure, Bar	Length of cutoff, m	Ground category	Diameter of pipe being pushed, mm	Dimensions (BxLxH), mm	Weight, kg
UGRM400	440	1250	700	90	I-V	1020,1220,1420	1665x1500x567	1112
UGRM600	660	1250	700	90	I-V	1220,1420,1620	1665x1500x1533	1712
UGRM800	880	1250	700	90	I-V	1620,1820,2020	1665x1500x1492	2418



Model: UGRM400



Support plate of pipe f1200 mm POT-1200 for UGRM600



Model: NEE-25AKK250T1



Model: NBR22/70-32/9P160-2Ku4B4

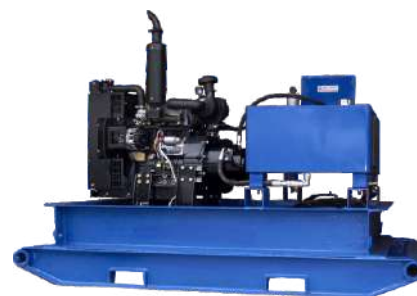

Model: NDR-18P160-1-KU3B3

Mobile and stationary complexes for liquid pumping-off and emergency operations

Series GNS... BR... GNS... DR...
Pressure - 170-250 Bar...



Pumps for liquid pumping-off as parts of GNS complexes

Parameters of hydraulic pumps

Model	Pump flow, m ³ /h	Height of liquid lifting, m	Diameter of spout	Ov. dimensions		Weight, kg
				Diameter	Height	
GNS-48BR	48	37	51	240	330	11
GNS-88BR	88	23	76	300	300	15
GNS-102DR	102	125	51	300	420	21
GNS-160DR	160	29	100	410	790	50
GNS-240BR	240	5	150	300	450	21
GNS-167DR	167	30	100	410	790	113
GNS-362DR	362	33	150	635	960	154
GNS-450DR	450	50	150	677	514	168

Parameters of hydraulic stations

Model	Flow L/min	Max. pressure, bar	Motor	HPH length, m	Hydraulic tank capacity, L	Fuel capacity, L	Ov. dimensions (LxBxH), mm	Weight, kg
GNS-48BR	20	175	Honda 13 h. p., petrol	coupled HPH 15 m, BRS	20	25	730x675x600	72
GNS-88BR	30	170	B&S Vangard 18 h. p., petrol	coupled HPH 15 m, BRS	20	25	870x740x700	127
GNS-102DR	60	240	Yanmar, Perkins 50 h. p., diesel	coupled HPH 60 m, BRS	160	125	1700x800x900	350
GNS-160DR	64	190	Yanmar, Perkins 50 h. p., diesel	coupled HPH 30 m, BRS	160	125	1700x800x900	350
GNS-240BR	30	170	B&S Vangard 18 h. p., petrol	coupled HPH 15 m, BRS	20	25	870x740x700	127
GNS-167DR	65	190	Yanmar, Perkins 38 h. p., diesel	coupled HPH 30 m, BRS	160	125	1700x800x900	270
GNS-362DR	100	210	Yanmar, Perkins 65 h. p., diesel	coupled HPH 30 m, BRS	200	125	2550x1200x1700	800
GNS-450DR	150	250	Deutz, Perkins 110 h. p., diesel	coupled HPH 60 m, BRS	400	300	2550x1200x1700	1600



Hydraulic station for GNS-362DR, with additional option on wheel-trailed base



Additional completing with hydraulic drum for HPH 60-100 m



Hydraulic station with diesel motor for GNS-160DR complex

Parameters of complexes

- Frame with integrated fuel tank;
- Automatic system of motor emergency shutdown;
- Axial-piston or gear-type pump;
- Manometer;
- Flow meter;
- Drain filter with indicator;
- Level of hydraulic liquid with thermometer;
- Radiator of hydraulic liquid cooling;
- Pumped-out media: dirty water, sludge, oil sludge, sand-containing liquids, chemically active liquids

Complex consists of:

- Hydraulic station, pump, hydraulic hoses, drain hose

Hydraulic stations of series NBR...A... are used as parts of complexes: GNS48BR; GNS88BR; GNS240BR page 56

Hydraulic stations for road-building tools, with electric drive

Series NER... A...
Pressure – 150 bar



Model: NER40A2

- Stations are designed for creation of pressure and supply of hydraulic liquid into hydraulic tools;
- Possibility of simultaneous connection of one or two operating hydraulic tools;
- Compact and rugged structure in steel frame, easier access to all bodies of hydraulic station;
- Volume of hydraulic tank is from 8 to 16 liters.

Model	Flow L/min	Max. pressure, bar	Electric motor	Starter	Options	Number of tools	Ov. dimensions (LxBxH), mm	Weight, kg				
NER20A1	20	150	5.5 kW, 3x380 V, 50 Hz	Electric box, start-stop	Cooler, thermometer	1	730x675x600	75				
NER20A2	20				Cooler, manometer, thermometer, hourmeter			75				
NER30A1	30		7.5 kW, 3x380 V, 50 Hz		Cooler, thermometer		870x740x700	115				
NER30A2	20-30				Cooler, manometer, thermometer, hourmeter			115				
NER40A1	40		11 kW, 3x380 V, 50 Hz		Cooler, thermometer		2	870x740x700	120			
NER40A2	20-30-40				Cooler, manometer, thermometer, hourmeter				120			
2NER40	20-30-40				20/20				Cooler, manometer, thermometer, hourmeter	2	870x740x700	125
	20/20								Cooler, manometer, thermometer, hourmeter			125

Hydraulic stations for road-building tools, with diesel drive

Series NDR... A...
Pressure – 140-150 bar



Model: NDR40A2

- Stations are designed for creation of pressure and supply of hydraulic liquid into hydraulic tools;
- Possibility of simultaneous connection of one or two operating hydraulic tools;
- Compact and rugged structure in steel frame, easier access to all bodies of hydraulic station;
- Volume of hydraulic tank is from 8 to 16 liters

Model	Flow L/min	Max. pressure, bar	Diesel motor	Starter	Fuel capacity, L	Options	Number of tools	Ov. dimensions (LxBxH), mm	Weight, kg
NDR20A1	20	140	7 л.с.	Manual or electric	5	Cooler, thermometer	1	730x675x600	80
NDR40A2	20-30-40	150	13 л.с.	Electric	7	Cooler, manometer, thermometer, hourmeter		870x740x700	132
NDR50A1	20-30-40-50	140	23 л.с.		25	Cooler, manometer, thermometer, hourmeter		1200x785x970	150

Hydraulic stations for road-building tools, with petrol drive

Series NBR... A...
Pressure – 150-200 bar



Model: NBR40A1

- Stations are designed for creation of pressure and supply of hydraulic liquid into hydraulic tools;
- Possibility of simultaneous connection of one or two operating hydraulic tools;
- Compact and rugged structure in steel frame, easier access to all bodies of hydraulic station;
- Volume of hydraulic tank is from 8 to 16 liters

Model	Flow L/min	Max. pressure, bar	Petrol motor	Starter	Fuel capacity, L	Options	Number of tools	Ov. dimensions (LxBxH), mm	Weight, kg	
NBR20A1	20	150	9 л.с.	Manual	5	Cooler, thermometer	1	730x675x600	72	
NBR20A2	20			Electric	5	Cooler, manometer, thermometer, hourmeter	1		72	
NBR20A3	20			Electric	7		1		75	
NBR20E	20			Electric	20	1	75			
NBR30A1	20-30		13 л.с.	Manual	6	Cooler, thermometer	1		730x675x600	75
NBR30A2	20-30			Manual	6	Cooler, manometer, thermometer, hourmeter	1			75
NBR30A3	20-30			Electric	7		1			78
NBR30E	20-30			Electric	20	1	75			
NBR40A1	20-30-40	200	18 л.с.	Manual or electric	7	Cooler, thermometer	1	870x800x700	125	
NBR40A2	20-30-40			Manual + electric	15	Cooler, manometer, thermometer, hourmeter	1		125	
2NBR40	20-30-40			7	2		125			
NBR40M	20-30-40			Electric	25	1	870x740x720		134	
2NBR20A3	1x20-30-40 (1 flow) 2 x 20 (2 flows)	150	18 л.с.	Manual + electric	15		2	870x800x700	133	

Hydraulic stations are used as power supply for the following hydraulic tools:

ROAD-BUILDING HYDRAULIC TOOLS

Coal hammers, concrete breakers, rotary saws, cutoff saws, perforators, pumps for pumping-over (water, sand, sludge, oil sludge), braces, nut wrenches, drills, welding generators, diamond chain saws and drills, wall cutting machines, grinding machines.

MANUFACTURER	
Hycon	Denmark
Hydra-Tech	USA
Partner и Husqvarna	Sweden
DOA Hydraulic Tools	Italy
Lifton	Belgium
Atlas Copco	Sweden
Stanley Hydraulic Tools	USA
ICS	USA
JCB	England

Multifunctional pumping unit

Series NDR...
Pressure — 140-800 Bar



Модель: НБР14/30/80-37/10/2ААИ63-2-БУ4ФС

It is designed to provide hydraulic power to the kit hydraulic and mechanical equipment for emergency recovery work used for lifting, moving alignment, and installation of rails of railway rolling stock, transport means, as well as bridges, metal structures and other structures. Installation and dismantling in industry, construction, transport and the like.

Pumping installation	Values
Working volume of pumps, cm ³ / rev:	
- 1st circuit:	8,0
- 2nd circuit:	2,84
- 3rd circuit:	0,71
Maximum contour pressures, MPa (kgf / cm ²)	
- 1st circuit:	14(140)
- 2nd circuit:	30(300)
- 3rd circuit:	80(800)
Feed rate when combining the 1 st and 2 nd contour, l / min:	
- in one-step mode	8,0
At a pressure up to 14MPa:	
- in two-stage mode	2,84
At a pressure up to 12MPa:	
At a pressure of 12 to 30 MPa:	0,71
Useful volume of oil tank, l	63
Fuel	Gasoline AI92, AI95, AI98
Number of simultaneously connected hydraulic equipment:	8
- hydrodynamic tools (saws, hammers, perforations-Tori, boers, pumps, etc.) at 14 MPa:	2
- Double-sided hydraulic jacks at 30 MPa:	4
- Hydrotool (gauges, scissors, one-sided Jacks) for 80 MPa:	2
Dimensions of the station in the frame (length x width x height), mm	
- with lowered handles	840x546x990
- with raised handles	1815x546x990
Weight, no more than, kg	
- without oil	140
- with a minimum working volume of refilled oil	165

Connecting rod pin pullers

Series SG...PN(V)
Capacity — 15,7-56 ton
Reach — 110-295 mm
Pressure — 700 Bar



Model: SG256-PN8

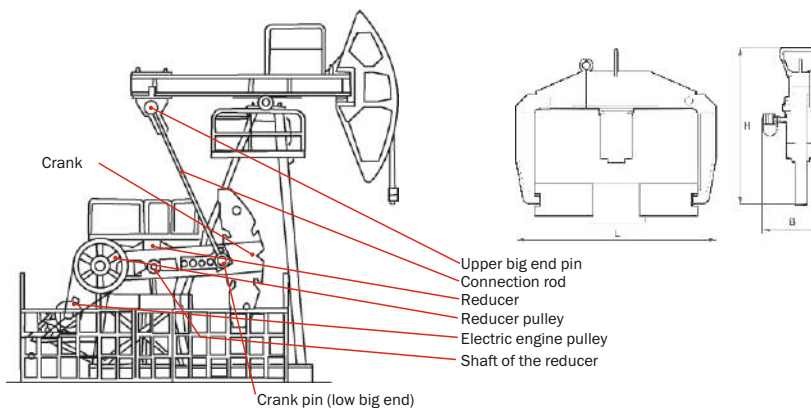

Model	Capacity, ton	Stroke, mm	Rocker-machine model	Max reach, mm	Oil working capacity, cm ³	Dimensions (BxLxH), mm	Weight, kg	Recommended pump
SG015-PN68	15,7	50	SK-6, SK-8	295	112	132x415x735	40	NRG-7010
SG235-PN6	35,8	50	SK-6	110	251	204x540x534	33	NRG-7020
SG235-PN8	35,8	50	SK-8	120	251	204x705x544	39,5	NRG-7020
SG256-PN6	56	50	SK-6	110	393	207x550x553	46	NRG-7010
SG256-PN8	56	50	SK-8	120	393	207x563x715	46,8	NRG-7010
SG256U-PN8	56	150	SK-8	120	1178	210x661x715	66	NRG-7020

Motor pulley pullers

Series SG...SH...
Capacity — 22,2 ton
Stroke — 360 mm
Pressure — 700 Bar



Model: SG322-SH68

Designed to remove engine pulley of the rocker-machine models SK-6 and SK-8 with a capacity of up to 22.2 tons. Fixed position of the pickup device over the entire removal range.

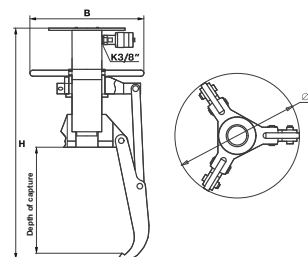

Model	Capacity, ton	Stroke, mm	Rocker-machine model	Outer diameter, mm	Max reach, mm	Oil working capacity, cm ³	Dimensions (BxLxH), mm	Weight, kg	Recommended pump
SG322-SH68	22,2	360	SK-6, SK-8	296	295	1122	220x296x907	45,3	NRG-7020

Crank spreaders

Series RK...
Capacity — 11,3 ton
Stroke — 35 mm
Pressure — 700 Bar



Model: RK6

Designed to remove the crank from the reducer shaft of the rocker-machine models SK-6 and SK-8 in the field conditions and in the workshop. 3 minutes are required to release a crank without spending time for by-work.

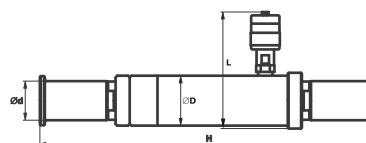

Model	Capacity, ton	Stroke, mm	Rocker-machine model	Outer diameter, mm	Max reach, mm	Dimensions (DxLxH), mm	Weight, kg	Recommended pump
RK6	11,3	35	SK-6	29	55,6	168x145x313	3,88	NRG-7010
RK8	11,3	35	SK-8	35	55,6	168x145x473	5,93	NRG-7010

Hydraulic tilt-rotary device “INTECH”

Series GSR...

Hydraulic tiltrotary device (TRD) “INTECH” is a mechanism between an operating beam (articulated crane, excavator, etc.) and rig (general-ground bucket, mulcher, gripper, clamp, etc.) designed to ease operation and increase an excavator capacity. TRD “INTECH” is of unlimited rotation through 360° and ability to fix in different planes with incline up to 40°.

Advantages of the tiltrotary device “INTECH”:

Integrity. TRD “INTECH” application transforms a basic machine into a universal equipped complex able to perform works of any complexity and in hard-to-reach places.

Economy. TRD “INTECH” application allows accelerating, simplifying, and increasing the accuracy of works being performed. Level of profitability of works performed is increasing; services range is widening.

Safety. TRD “INTECH” facilitates the work of an operator while making it safer. Moreover, safety is increasing in the excavator working area since the works are being performed in the smaller area.

Easy-to-operate. All works with TRD “INTECH” are carried out by single operator.

A quick replacement of the rig. When using TRD “INTECH”, the rig can be replaced in a matter of minutes while there is no need for an operator to move, change or leave the machine.

TRD “INTECH” can be installed on home-produced and foreign excavators.

We provide guarantee and after-guarantee maintenance of TRD “INTECH”. Installation of equipment, diagnostics of working efficiency, adjustment and repair are performed by a mobile team of the Company maintenance engineers.

When buying TRD “INTECH”, you get an integrated solution for performing almost all contracts for land works!

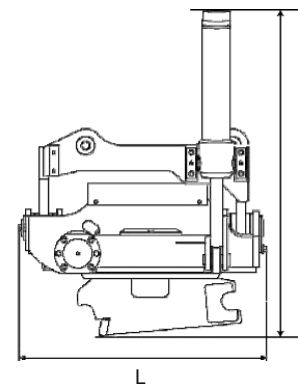
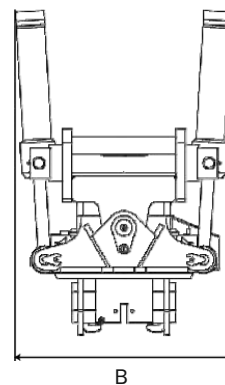

Model: GSR-020

Model	Overall dimensions (BxLxH), mm	Tilt angle	Weight, kg	Required flow of fuel, (L/min)	Operating pressure, Bar	Installation on all excavators with weight of..., tons
GSR005	510x515x854	2x40°	145	1540	180-210	36
GSR010	633x790x991	2x40°	345	2040	180-210	614
GSR020	700x770x810	2x40°	450	4080	180-210	1624



Attached equipment

Special rigs for TRD INTECH widen an excavator application range significantly. All rigs are installed on excavators weighting 3-24 tons.

Upon the customer's request, the company adapts the rigs of own production and of other producers for fixing the tiltrotary device INTECH; this provides effective interaction in the system "machine TRD rigs" and allows to avoid mismatches in the equipment installation.

Bucket for backhoe GSR-005 / 1.1 GSR-010 / 1.1 GSR-020 / 1.1



Special attachments equipment for hydro manipulator "INTECH" seriously expands the application of excavators. All equipment is mounted on excavators weighing 3-24 tonnes.

Clamshell GSR-005 / 3.2 GSR-010 / 3.2 GSR-020 / 3.2



Used for loading-unloading works, sorting, re-screening of reloaded material and destruction of stone and wooden structures.



Planning bucket GSR-005 / 1.2 GSR-010 / 1.2 GSR-020 / 1.2

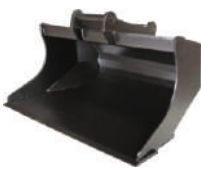

Used for embankment planning and for displacement of friable soft soil. Bucket volume - 0,25-1m³

Trench bucket GSR-005 / 1.3 GSR-010 / 1.3 GSR-020 / 1.3



Designed for use in limited areas and for digging narrow trenches (for cabling and other), providing for deeper digging depth. Teeth package is ordered separately. Bucket volume - 0,04-1 m³



Ripper GSR-005 / 5 GSR-010 / 5 GSR-020 / 5



Ripper (knife for frozen soil) is used for ground works on frozen or hard soil, specially cultivation and crushing of hard materials.

Fork grip GSR005 / 6 GSR-010 / 6 GSR-020 / 6



Versatile instrument ensuring good overview for operator, smooth forks opening. Designed for lifting, relocation, loading- unloading and piling of loads



Digging clamshell GSR-005 / 3.1 GSR-010 / 3.1 GSR-020 / 3.1



To perform work on the excavation to a depth digging to greater depths, loading and unloading of bulk materials, gravel to repair the upper structure of railway track when replacing the gravel in the sleeper compartment. Bucket capacity 0.04 m³

Extra integratable clamshell GSR-005 / 2.1 GSR-010 / 2.1 GSR-020 / 2.1



For work at construction sites, with posts, borders etc; for pipe, effluent disposal lines fitting; for work with scrap metal; for beams and rail loading.



* Overall dimensions of equipment are defined in the design process and can be changed for a special item type in accordance with individual order.

Flange spreaders

Series RF...

Capacity — 1,5 - 12 ton

Flange diameters — 80 - 1600 mm



Model: RFV250



Model: RF101600



Model: RFA1600

Allows to scrap outworn methods of adjustment of flanges of pipelines for replacing gaskets, blinding, replacement or revalving on the main oil and gas pipelines, heating stations, sanitary-engineering system.

— Flange spreader RFV250 is mechanical and the most convenient for adjustment of the flanges when significant effort is required for the adjustment;

— Hydraulic spreaders have two wedges that provide effective and safe spreading of the flanges

— Hydraulic spreader RFA1600 with built-in pump is easy to use when working in limited spaces or at height.

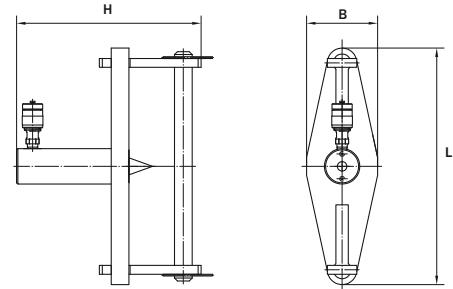

Model	Capacity, ton	Width of spread, mm		Flange diameters, mm	Dimensions (BxLxH), mm	Weight, kg	Recommended pump
		1st head	2st head				
RFV250	1,5	0-15	—	80-250	76x130x215	2,2	—
RF05800	5	0-20	18-35	32-800	76x210x255	4,5	NRG-7010
RF101600	10	0-27	25-50	225-1600	108x280x297	8,9	NRG-7010
RFA1600	12	0-27	25-50	225-1600	460x280x510	14,3	built-in

Hydraulic spreaders

Series KR..., KRA...

Capacity — 1-2,5 ton

Pressure — 600/700 Bar



Model: KRA1150

Spreader is used for correct installation, setting-out of the equipment on the foundation and by the expansion of the narrow openings.

— Compact, lightweight and easy to use;

— The minimum required clearance is 25 mm;

— The corrugated surface prevents the slipping of the load.

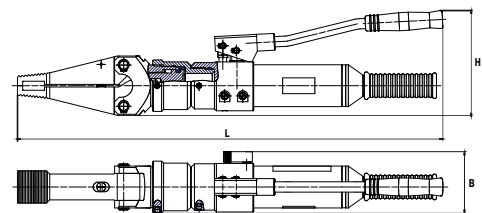

Model	Capacity, ton	Min clearance required h, mm	Max spread H1, mm	Working oil capacity, cm ³	Dimensions (BxLxH), mm	Weight, kg	Recommended pump
KR1150*	1	34	150	30	71x359x92	5,8	NRG-7004A
KRA1150*	1	34	150	30	96x661x163	9,2	built-in
KR2, 5120	2,5	25	120	40	80x339x110	9,2	NRG-7004A

* — Pressure 600 Bbк

* — As an alternative to the wedges, the expansion of RB-310, R-120, RU-120 with the use of the power module KRUG-1 Page 65.

Trolley lifter for inspection pits

Series PGP...M...
Capacity — 16,5 ton



Model: PGP16M750

Designed to display front or rear axles, during repair or maintenance of the vehicles.

- Installed on a lift platform or repair pit;
- Possibility to move the lift along the repair pit, and move a trolley with a hydraulic cylinder and pump in a transverse direction;
- Built-in hydraulic pump ensures ease of use in limited spaces.

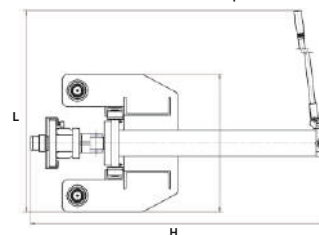

Model	Capacity, ton	Stroke, mm	Track width, mm	Oil capacity, sm ³	Dimensions (BxLxH), mm	Weight, kg
PGP16M750	16,5	750	1350	2500	590x1410x1275	344

Pressing-out pintle tool

Series VSH...
Capacity — 35,8 ton



Model: VSH35

Designed to press-out fulcrum pins. Withdrawal tool may be used as a press to remove details in pressure couplings.

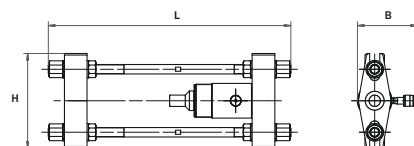

Model	Capacity, ton	Stroke, mm	Dimensions (BxLxH), mm	Weight, kg	Recommended pump
VSH35	35,8	50	172x770x300	42	NRG-7004A

Pressing-out track pin tool

Series VSH...
Capacity — 109,8 ton



Model: VSH100A

Hydraulic pressing-out tool is designed to withdraw caterpillar band pins of harvesters and road building machines. Tool may be used as a press to remove details in pressure couplings.

Model	Capacity, ton	Stroke, mm	Dimensions (BxLxH), mm	Weight, kg	Recommended pump
VSH100A	109,8	250	317x1420x335	82,4	NRG-7080R

PSC strand tightener

Series UN...
Capacity — 25 ton
Stroke — 600 mm



Model: UN25-600

PSC strand tightener is designed for tension of PSC strand in prestressed concrete constructions, in seismic belt etc. The product must be used in areas with temperate climate where the air temperature is minus 30 °C to 40 °C, or 25° if the relative humidity is 80%.



Model	Capacity, ton	Stroke, mm	Nominal pressure, Bar	Oil working capacity, cm ³	Oil volume for cavity fill, cm ³	Dimensions (BxLxH), mm	Type of rope	Weight, kg
UN22-200	25	200	650	754	382	254x555x189	15K7GOST13840-68	25,2
UN25-600	25	600	650	2261	1145	255x955x189		48,1

Oil injector

Series IM...
Pressure — 3000 Bar



Model: IM300.1

Oil injector is designed for dismantling of press fitted parts (bearings, plugs, tooth wheels, etc.) with hydraulic thrust device

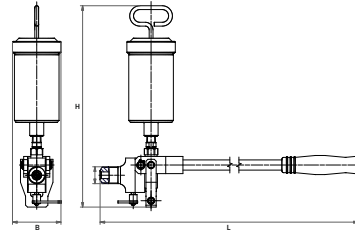

* Adapter for injector connection to the shaft is out of the scope of supply; it is manufactured by the user by its own means or ordered additionally.

Model	Rated pressure, Bar	Output, cm ³ /stroke	Pivot angle of handle, deg.	Max. capacity on handle, kgf	Rated volume of tank, cm ³	Range of ambient temperatures, °C	Ov. dimensions (BxLxH), mm	Weight, kg
IM300.1	300	0,23	35	35	200	from - 10 to + 40	76x448x316	3,14

Installation for geophysical equipment testing

Series SIG...
Capacity – 24,4 tons
Length of equipment being tested, mm – 1000-3000

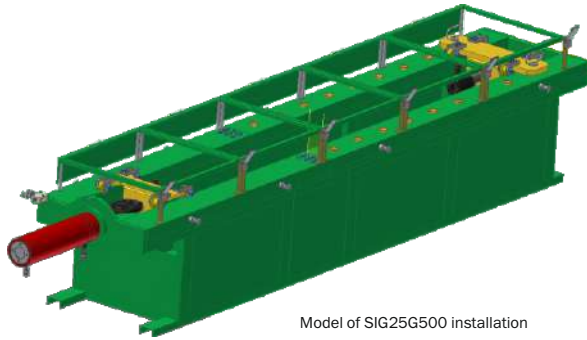

Model of SIG25G500 installation

Major component parts of the installation are as follows:

Frame, hydraulic cylinder, carriage, pin-lock of the carriage, moveable carriage, load cell fixation, load cell, weighing indicator, digital pressure gauge, lifting screws, enclosure, high pressure hoses.

The installation is designed for static and dynamic testing of geophysical equipment for compression and stretching.

Testing on the installation is performed due to stretching or compression generated by the hydraulic cylinder rod movement and keeping under load for the specified time. Ends of the tested equipment are inserted into cap fittings and fixed with pin-locks.

The cylinder rod is extended due to force generated when hydraulic liquid is supplied under pressure into the head end. The rod is returned to the initial position when hydraulic liquid is supplied into the cylinder rod end.

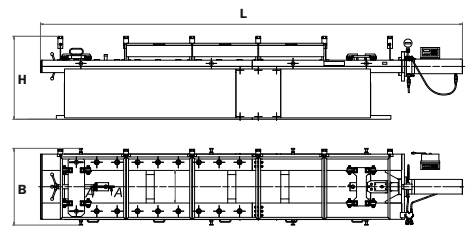

Model	Capacity, ton	Pushing/pulling pressure, Bar	Stroke of hydraulic cylinder rod, mm	Diameter of equipment being tested, mm	Length of equipment being tested, mm	Compressive and tensile force of the device, ton	Overall dimensions (BxLxH), mm	Overall dimensions of installation in transport position (BxLxH), mm front frame with hydraulic cylinder / rear frame	Weight, kg
SIG25G500	25,4/25,4	165/220	500	65 – 300	1000 – 3000	0,5 – 25	940×5172×1017	940×2577×1017/ 940×2745×1017	1200

Valving test equipment



Valving test equipment is designed to test structural integrity of the shut-off valves built-in technological pipelines, new and after repair.

The principle of operation of the setup is based on the formation of a hermetically closed space in the enclosure of the test valving with self-aligning cones, one of which is mobile and moves with help of the hydraulic cylinder.

For work equipment must be equipped with:

- Pumping NER-1,6I10T1(F1) and hoses RVD2000;
- Pumping NEE-1,6I10T1(F1) and hoses RVD2000;
- The customer must have a source of pressure of the test environment.

Parameters	Clamping capacity, mm	Pipe size of the test valving, ton	Max pressure, Bar	Length of the valving, mm	Dimensions (BxLxH), mm	Weight, kg	Recommended pump
Values	200	50,65,80,100,110,125,150,175,200, 225,250	38	360-800	965x250x1520	1100	NEE-1,6I10T1(F1)

Grimping sling ropes presses

Series PS...

Capacity – 400 ton

Pressure – 320 Bar

Crimping press PS400 is designed to crimp the cable ends having diameter of 8 to 37 mm with aluminum ferrule.

The following pump with electric-contact pressure gauge NEE12/32-32 /12I160T2-My is recommended for work, as well as model NEE12/32-16/6I63T2-Mu and hoses RVD12.7. 166.2500.0,18.13/13-90G1/2G1/2-y1 2 pcs.

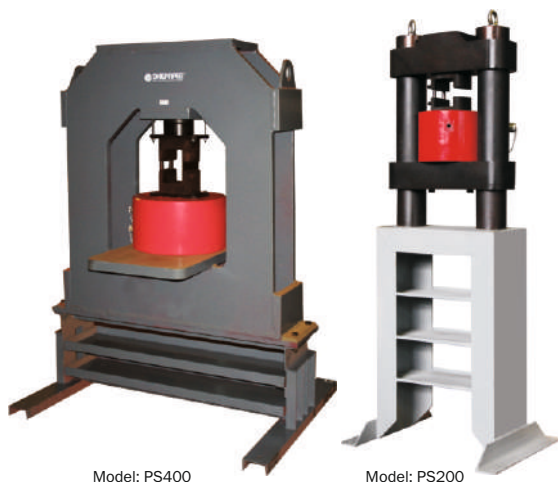

Model: PS400

Model: PS200



NEE12/32-32/12I160T2-Mu

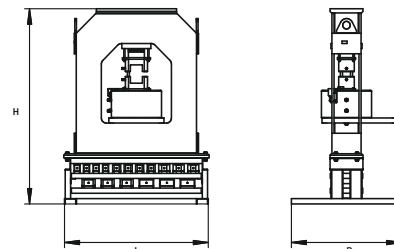

Model	Capacity, ton	Stroke, mm	Oil working capacity, cm ³	Dimensions (BxLxH), mm	Weight, kg	Recommended pump
PS200	202	30	618	500x660x1577	331	NEE12/32-32/12I160T2-Mu NEE12/32-16/6I63T2-Mu
PS400	400	50	7536	1100x1450x1912	1419	

Set of dies for PS200				
Crimping ferrule DIN3093	Steel cable Diameter, mm	Die dimensions, Height x length x width, mm	Designation	1 Die weight, kg
Um4,5	4,0...4,5	35x84x40	Um 4,5	1,8
Um5	4,6...5,1		Um 5	1,8
Um6	5,2...5,7		Um 6	2,2
Um6,5	5,8...6,4	35x84x50	Um 6,5	2,2
Um7	6,5...7,3		Um 7	2,2
Um8	7,4...8,2		Um 8	2,2
Um9	8,3...9,0	35x84x60	Um 9	2,6
Um10	9,1...10,1		Um 10	2,6
Um11	10,2...11,2		Um 11	2,5
Um12	11,3...12,3		Um 12	2,5
Um13	12,4...13,4	35x84x80	Um 13	3,2
Um14	13,5...14,5		Um 14	3,2
Um16	14,6...16,1		Um 16	3,1
Um18	16,2...18,2	35x84x100	Um 18	3,0
Um20	18,3...20,2		Um 20	3,6

Set of dies for PS400				
Crimping ferrule DIN3093	Steel cable Diameter, mm	Die dimensions, Height x length x width, mm	Designation	1 Die weight, kg
Um9	8,3...9,0	65x120x60	Um 9	3,55
Um10	9,1...10,1		Um 10	3,53
Um11	10,2...11,2		Um 11	3,51
Um12	11,3...12,3		Um 12	3,48
Um13	12,4...13,4		Um 13	4,49
Um14	13,5...14,5	65x120x 80	Um 14	4,45
Um16	14,6...16,1		Um 16	4,40
Um18	16,2...18,2		Um 18	4,33
Um20	18,3...20,2		Um 20	5,40
Um22	20,3...22,4	65x120x 110	Um 22	5,32
Um24	22,5...24,6		Um 24	5,22
Um26	24,7...26,9	65x120x 130	Um 26	6,32
Um28	27,0...28,6		Um 28	6,15
Um30	28,7...30,8		Um 30	6,00
Um32	30,9...32,7		Um 32	6,74
Um34	32,8...34,9		Um 34	6,49
Um36	35,0...37,1	65x120x 145	Um 36	6,27

Model	Nominal Pressure mPa/Bar, (kgs/cm ²), 1/ 2 stage	Pump rate, l/min., 1/ 2 stage	Power fluid	Effective tank volume, l	Pump drive	Dimensions (BxLxH), mm	Weight, (with dry tank), kg
NEE12/32-16/6I63T2-Mu	12 (120)/32(320)	16/6	Hydraulic oils	63	N=4,0 kW; 380 V	514x650x850	85
NEE12/32-32/12I160T2-Mu	12 (120)/32(320)	32/12		160	N=7,5 kW; 380 V	620x640x960	140

Sling ropes test machine

Series SISG...
Capacity — 12,5 - 100 ton
Sling length — 1-16 m



The sling testing device is designed for tension test of rope, chain and textile slings. The tool is commonly applied in various branches of the industry where rope slings are used. Setups can be equipped with additional digital pressure gauges, which show a tension at strap in tones. Pumps of the tensioner SISG10-3 is configured to auto-maintenance of the tension during the period required to test the slings.

Model	Capacity, ton	Stroke, mm	Sling length, m	Dimensions (BxLxH), mm	Setup Weight, kg	Recommended pump
SISG 10-3	12,5	600	1-3	1100x4950x993	970	NEA-1,6I10T1-C
SISG 20-10V*	21,9	500	1-10	1090x4476x993	970	NRG, NER, NEE, NEA
SISG 20-16	20,1	500	1-16	1110x9086x993	1600	NRG..R NER, NEE, NEA
SISG 100-16	100	630	1-16	974x 10405x876	2400	NEE-1,6I20T1

* — Pneumatic stroke retraction

Splicing sling ropes machine

Series PZS. . .
Diameter of splicing sling— 10-60 mm

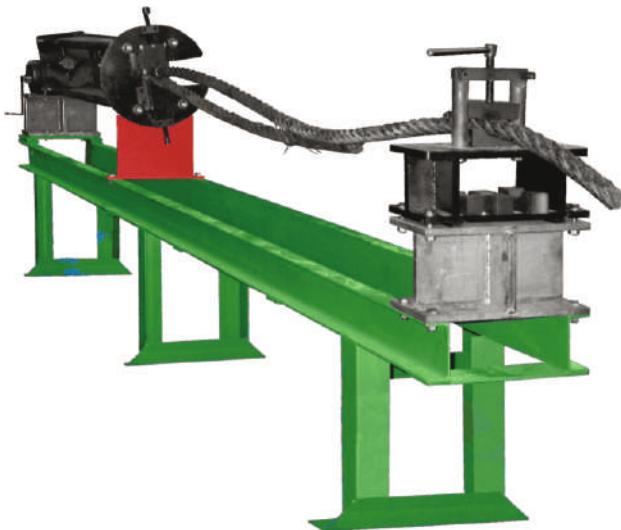

The machine is designed to form sling loops on the steel rope (cable) that is, to make sub-slings. Device provides unwinding and stretching of the spliced part of the cable and then covering of the spliced part. Cable is fastened in special clamps, then stretched and unwound. Then it is spliced and covered.

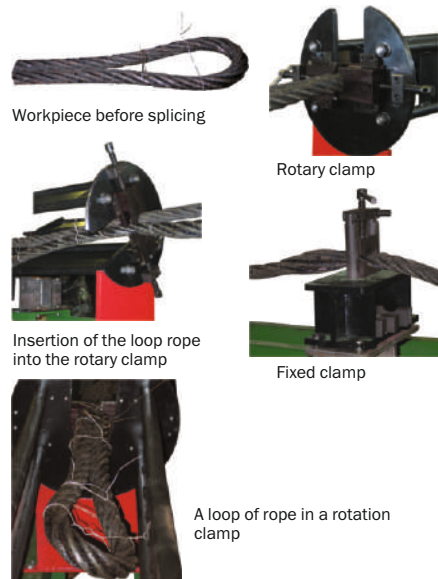

Model	Diameter of the spliced sling, mm	Dimensions (BxLxH), mm	Weight of device, kg
PZS30	10-30	1500x534x1452	180
PZS60	10-60	5000x600x1504	618

Small spreader R-120



The special shape of the levers allows to move, push, lift various objects with a slight gap between the support and the load, work in confined spaces, providing a great capacity.

Parameters	Value
Spreading capacity, ton (kN)	3,5 (34,3)
Width of spread, min, mm	120
Dimensions(BxLxH), mm	83x258x95
Weight, kg	3,2

Attachment for wagon moving NSV



Serves as a lever stop for car breakaway with help of the large spreader (RB-310)

Parameters	Value
Dimensions (BxLxH), mm	166x325x100
Weight, kg	4,8

Accessories KRUG-1C, KRUG-AM

Parameters	Value
K-270	Wedge
U-140	Extension



K-270



U-140

On request, sets of wheels and circles-1C-AM can be equipped with a mechanical wedge K-270 and extends handle U-140.

KRUG-2M

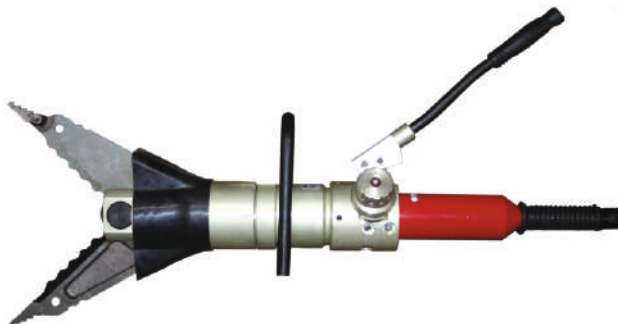

Parameters	Value
Nominal cutting capacity, ton (kN)	29 (284)
Spreading capacity at the lever ends, max, ton (kN)	4,2 (41,2)
Clamping capacity at the lever ends, max, ton (kN)	5,2 (51)
Opening of the lever ends, max, mm	300
Cut rod diameter, mm	20
Cut pipe diameter, mm	30
Nominal Pressure, Bar	700

Used during special, emergency, installation and dismantling, repair and construction works;

Easy to operate;

For a relatively small weight (15 kg) has the advanced functional characteristics: displacements, lifting, cutting.

Parameters	Value
Volume of the filling hydraulic oil, cm ³	230
Rotation the rocker arm, degree	55
Handle capacity, max, kgf	29
Performance, cm ³ /stroke, 1 stage	9,3
2 stage	1,27
Ambient temperature range, °C	от - 40 до + 80
Dimensions, (BxLxH), mm	191x912x243
Weight, kg	15

Inclined spreader RU-120



Angular design is preferable for specific operations in hard-to-reach places (opening of metal doors, lifting lying cargo in a confined space, etc.).

Parameters	Value
Spreading capacity, ton (kN)	3,3 (32,3)
Width of spread, min, mm	120
Dimensions(BxLxH), mm	68x214x159
Weight, kg	4

Sheet cutter NL-5



Used as a cutting tool, providing greater cutting capacity. Designed to cut metallic sheets.

Parameters	Value
Cutting thickness, mm	5
Cutting Length for 1 stage, mm	50
Dimensions (BxLxH), mm	54x208x144
Weight, kg	3,1

KRUG-2S



For the speedy execution of various works in hard-to-reach places, in emergency situations, completed with two quick-change attachments: P-300 - for spreading, lifting objects; N-20 - for cutting

The set is designed for rescue, construction and demolition.

Characteristics of the KRUG-2S

Dimensions (with attachment-cutter / with combined attachment), (BxLxH), mm - 189x836x254/189x917x240
 Ambient temperature range, °C -40 to +80
 Weight, max, kg
 With attachment-cutter - 14,7
 With combined attachment - 16,1
 Total - 22,6
 Number of fixed positions of attachments - 4 units

Power module KRUG-2

Parameters	Value
Nominal Pressure, Bar	700
Volume of the filling hydraulic oil, cm ³	230
Rotation angle the rocker arm, degree	55
Handle capacity, max, kgs	29
Performance, cm³/stroke:	
1 Stage	9,3
1 Stage	1,27
Dimensions (BxLxH), mm	191x549x224
Weight, kg	8,0

Combined attachment R-300



Allows moving, spreading and lifting of various objects with a slight gap between the support and the load, work in confined spaces, providing greater capacity.

Parameters	Value
Nominal cutting capacity, ton (κN)	29 (284)
Spreading at the lever ends, min, ton	4,2 (41,2)
Clamping capacity at the lever ends, max, ton (κN)	5,2 (51)
Opening of the lever ends, max, mm	300±5
Cut pipe diameter, mm	22
Hardness cut diameter, mm	200
Dimensions (BxLxH), mm	107x413x187
Weight, kg	7,6

Cutter N-20



Used as a cutting tool, providing greater cutting pressure. Designed for cutting metal rods, car racks and steering columns of the cars.

Parameters	Value
Nominal cutting capacity, ton (κN)	29 (284)
Opening of the lever ends, max, mm	150±5
Cut rod diameter, mm	30
Dimensions(BxLxH), mm	107x333x187
Weight, kg	6,4



KRUG-2S in operation



Compact hydraulic equipment for quick lifting and re-railing of LV cars (HARS-300)

Set of equipment is designed for emergency recovery, lifting, moving, leveling and installation on the rails of wagons and rolling stock units (pressure 300 Bar).

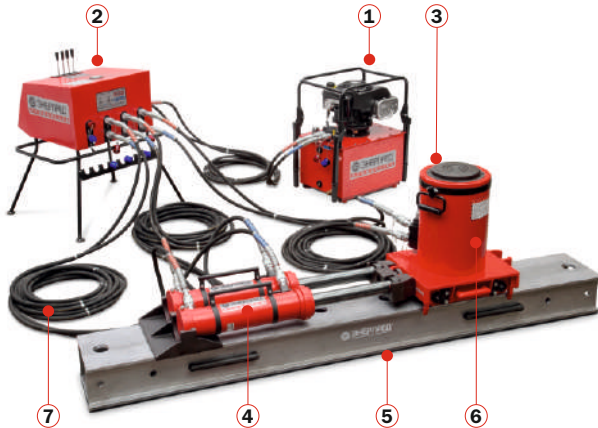

Main elements of the system are:

1. Hydraulic station - a device for creating pressure and oil supply to the jacks and cylinders.
2. Control panel - a device for controlling the flow of the hydraulic system.
3. Jack hydraulic - the device for lifting and lowering the rolling stock.
4. The displacement cylinder is a device for transversely moving the roller carriage over a bridge beam.
5. Bridge beam - a device for installing a roller trolley, jacks and cylinders on it for the purpose of lifting and moving the rolling stock.
6. Roller trolley - a device for transverse movement of rolling stock on a bridge beam.
7. High pressure hose - a device for connecting all elements of the hydraulic system.

DRIVE AND CONTROL

PUMP STATIONS



NBR30-7A40-1

NBR30-7A40-1BU4

MANUAL PUMPS



NRG30200R3
(folded and in working condition)

HIGH-PRESSURE HOSES



2RVD30-10000

REMOTE CONTROL



PU-4

Are intended for creation of pressure and submission of a hydraulic liquid in devices of system ENERPRED, for statement of a rolling structure on rails.

Model	Feed pump, l/min	Tank capacity, l	Dimensions BxLxH, mm	Weight, Kg
NBR30-7A40-1	8,0	40	400x620x755	57
NBR30-7A40-1BU4	8,0	40	530x625x920	70
NBR30-11A63-1	11,0	63	630x460x950	95
NBR30-3,6A20-1BY2	3,6	20	400x610x675	45
NER30-5,7A40T1	5,7	40	400x620x755	57
NER30-10A63T1	10,0	63	535x560x880	83
NER30-3,6A20T1BU2	3,6	20	300x520x820	45
NER30-5,7A40T1BU4	5,7	40	300x520x820	72
NDR30-11A40-1	11,0	40	542x700x830	94
NDR30-11A63-1	11,0	63	542x700x970	99
NDR30-11A100-1	11,0	100	542x700x1320	108

Are intended for creation of pressure and submission of a hydraulic liquid in devices of system ENERPRED, for statement of a rolling structure on rails.

The manual drive of the pump makes it independent of power supply and fuel.

Model	Number of tools	Tank capacity, l	Dimensions BxLxH, mm	Weight, kg
NRG30200R	1	20	435x910x710	28
NRG30200R2	2	20	435x910x710	31
NRG30200R3	3	20	435x910x710	37

Designed to connect all the devices of the hydraulic system ENERPRED, to stop the rolling stock on the rails.

Model	Length, mm	Weight, kg
2RVD30-5000	5000	8
2RVD30-10000	10000	14

Are intended for management (distribution of a hydraulic stream) work of devices of system ENERPRED, for statement of a rolling stock on rails.

Model	Number of tools	Dimensions BxLxH, mm	Weight, kg
ПУ-4	1	435x910x710	28
ПУ-6	2	435x910x710	31

RISE

JACKS



Designed for carrying out lifting, holding and lowering operations of rolling stock on rails.

Model	Carrying capacity, tons	Rod stroke, 1/2 step, mm	Jack height, mm	Weight, kg
DTA40/20G230-250	46/19	120/110	250	25
DTA40/20G500-420	46/19	250/250	420	41
DGA60Г110-250	68	110	250	35
DTA60/30G215-250	68/27	110/105	250	36
DGA60Г250-420	68	250	420	51
DTA60/30G500-420	68/27	240/260	420	56
DGA120G50-160	116	50	160	41
DGA120G90-250	116	90	250	46
DGA120G120-315	116	120	295	55
DGA120G250-420	116	250	420	64
DTA120/60G180-250	116/57	90/90	250	54
DTA120/60G500-420	116/57	250/250	420	75
DTA120/60/30G700-420	116/57/23	245/245/210	420	80

SUPPORTING SUPPORT AND SUPPORT



Designed to increase the lifting height jacks ENERPRED. Provide greater stability when working with ENERPRED jacks during lifting, holding and lowering of rolling stock.

Model	Jack used	Increase stroke, mm	Weight, kg
KN40-2	DTA40/20G230-250	360	29
KN60-2	DGA60G110-250 DTA60/30G215-250	320	40
KN120-1	DGA120G50-160	100	16
KN120-2	DGA120G90-250 DTA120/60G180-250	260	30
KN120-3	DGA120G120-315	380	50
OPA40	DTA40/20G230-250 DTA40/20G500-420	-	8
OPA60	DGA60G110-250 DTA60/30G215-250 DGA60G250-420 DTA60/30G500-420	-	10

MOVEMENT

BRIDGE BEAMS

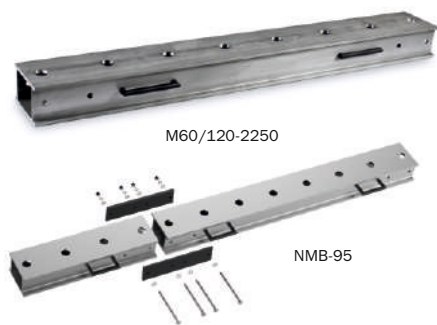

They are designed for moving roller skids on them and are the main supports when lifting, holding and lowering the rolling stock of the ENERPRED jacks.

Model	Length, mm	Width, mm	Height, mm	Weight, kg
M60-1200	1200	275	95	32
M60-2250	2250	275	95	65
M60-3300	3300	275	95	95
M60/120-1200	1200	275	175	41
M60/120-2250	2250	275	175	88
M60/120-3300	3300	275	175	128
NMB-95	Set for connecting bridge beams		95	12
NMB-180			175	27

ROLLER TROLLEYS

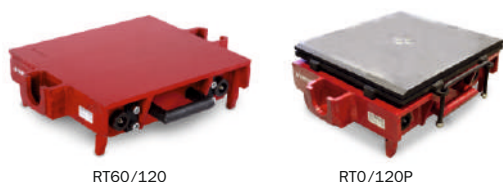

They are designed to move the rolling stock in the transverse direction along the bridge beam and are the supporting and mobile platform for the ENERPRED jacks.

Model	Mark	Height, mm	Weight, kg
RT60/120	-	110	70
RT60/120P	With swivel plate	140	103

SPLASH BEAMS



Are intended for connection of two roller carriages ENERPRED with transverse moving of a rolling stock.

Model	Min. length in working order, mm	Max. Length in working condition, mm	Weight, kg
RB-1	922	1877	12
RB-2	1046	2645	18

CYLINDERS OF DISPLACEMENT

CP15G350-575



CP15G350FG

STEERING MOUNTS

KCP



DKCP



DSSHC



FRT + KCP



FCP

WHEEL PAIR PULLEY

TKP-1500

It is designed for the transverse movement of a roller carriage on the bridge beam ENERPRED.

Manual repositioning - manually changing the position of the displacement cylinder on the bridge beam.

Hydraulic repositioning - automatic repositioning of the displacement cylinder on the bridge beam.

Model	Force pushing/retracting, ton	Rod stroke, mm	Weight, kg
CP15G350-575	13/8,5	350	22
CP15G350FG	15/12	350	26

Are intended for connection with a bridge beam and a roller carriage of the ENERPRED displacement cylinder.

Model	Name	Weight, kg
KCP	Единая встречная поддержка	7
DKCP	Double counter	13
DSSHC	Double connection piece	11
FTR	Roller trolley lock	12
FCP	Travel Cylinder Clamp	19

It is intended for installation of a rolling stock in a track in cases when it has been put on a crest of a wheel during lowering on rails.

Model	Cable length, mm	Width between cables, mm	Weight, kg
TKP-1500	1720	380	49

* Cylinder displacement CPU15G350-575 is not included in the scope of supply

STATEMENT OF DAMAGED WAGONS
CURRENT SYSTEM

DGA35G825-1030K

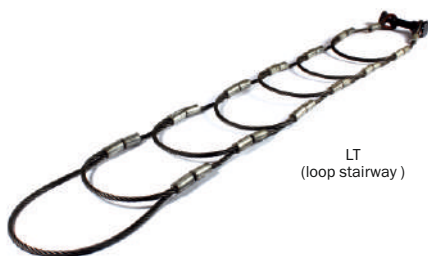
 LT
(loop stairway)

 Kt4
(mounting cable)

 Ut4
(holding cable)

Rope system is designed for putting on the rails an overturned on the side or a strongly tilted car.

Model	Name	Carrying capacity, tons	Rod stroke, mm	Length, mm	Weight, kg
DGA35G825-1030K	Jack	35	825	-	83
LT	Rope ladder loop	-	-	3100	35
KT4	Mounting cable	-	-	4000	10
UT6	Retaining cable	-	-	6000	15
NVD	Lining kit	-	-	-	30



 NVD
(jacking)

 NDV
(rounded jack support)

 NVD
(special support)

Compact hydraulic equipment for fast lifting and installation on rails of light vehicles (HARS-500)

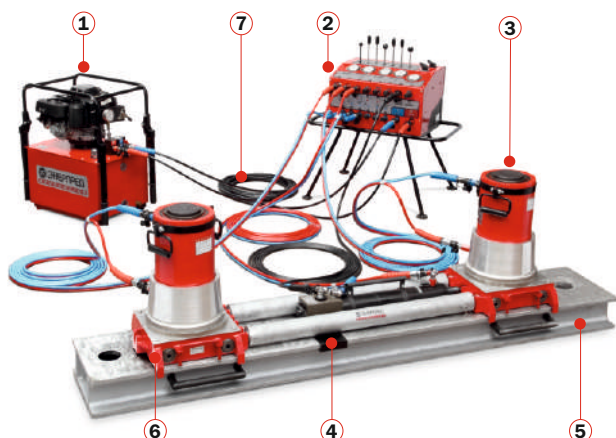
A set of hydraulic from light alloys "HARS" for setting wagons on rails (pressure of 500 Bar).



Main elements of the system are:

1. Hydraulic station - a device for creating pressure and oil supply to the jacks and cylinders.
2. Control panel - a device for controlling the flow of the hydraulic system.
3. Jack hydraulic - the device for lifting and lowering the rolling stock.
4. The displacement cylinder is a device for transversely moving the roller carriage over a bridge beam.
5. Bridge beam - a device for installing a roller trolley, jacks and cylinders on it for the purpose of lifting and moving the rolling stock.
6. Roller trolley - a device for transverse movement of rolling stock on a bridge beam.
7. High pressure hose - a device for connecting all elements of the hydraulic system.

DRIVE AND CONTROL

PUMP STATIONS



NBR50-6A40-2

NER50-6A40T2

MANUAL PUMPS



NRG50100R2
(folded and in working condition)

HIGH-PRESSURE HOSES



RVD50-10000

2RVD50-10000

REMOTE CONTROL



PU50-6

Are intended for creation of pressure and submission of a hydraulic liquid in devices of system ENERPRED, for tatement of a rolling structure on rails.

Model	Pump flow, low/high pressure, l/min	Tank capacity, l	Dimensions BxLxH, mm	Weight, kg
NBR50-6A40-2	5,9/3,2	40	410x623x705	59
NER50-6A40T2	5,3/3,3	40	410x623x685	58
NDR50-6A40-2	5,9/3,2	40	542x700x830	95
NBR50-4,7A20-2-BU2	4,7/1,5	20	440x570x730	53

Are intended for creation of pressure and submission of a hydraulic liquid in devices of system ENERPRED, for statement of a rolling structure on rails.

The manual drive of the pump makes it independent of power supply and fuel.

Model	Number of tools	Tank capacity, l	Dimensions BxLxH, MM	Weight, kg
NRG50100R1	1	10,5	437x909x460	24
NRG50100R2	2	10,5	437x909x460	25
NRG50100R3	3	10,5	437x909x460	25
NRG50200R4	4	20	437x909x550	31

Are intended for connection among themselves of all devices of hydraulic system ENERPRED, for a stop of a rolling stock on rails.

Model	Length, mm	Weight, kg
2RVD30-5000	10000	4
2RVD30-10000	10000	7

Are intended for management (distribution of a hydraulic stream) work of devices of system ENERPRED, for statement of a rolling stock on rails.

Model	Number of tools	Dimensions BxLxH, mm	Weight, kg
PU50-3	2	535x560x890	36
PU50-4	3	535x560x890	40
PU50-6	4	640x820x940	61

RISE

JACKS



DTA65G450

DTA110G400

DTA170G500

DTA110G185

SUPPORTING SUPPORT AND SUPPORT

DTA110G400 + KN110-2 + OPDA110



DTA110G400 + KN110-2 + OPDA110

DTA170G500 + OPDA170



OPDA170

Designed for carrying out lifting, holding and lowering operations of rolling stock on rails.

Model	Carrying capacity, tons	Rod stroke, 1/2 step, mm	Jack height, mm	Weight, kg
DTA65G185	67/28	95/90	215	14
DTA65G280	67/28/104	90/95/95	215	15
DTA65G450	67/28	223/227	385	24
DTA110G185	110/50	89 / 96	234	27
DTA110G400	110/50	195/204	398	41
DGA130G115	115	115	398	36
DTA170G500	168/72	250/251	450	68

Designed to increase the lifting height jacks ENERPRED. Provide greater stability when working with ENERPRED jacks during lifting, holding and lowering of rolling stock.

Model	Jack used	Increase stroke, mm	Weight, kg
KN65	DTA65G185 DTA65G280 DTA65G450	260	16
KN110-1	DTA110G185	260	27
KN110-2	DTA110G400	360	41
KN130	DGA130G115	495	47
KN170	DTA170G500	400	49
OPDA65	DTA65G185 DTA65G280 DTA65G450	-	7
OPDA110*	DTA110G185 DTA110G400	-	9
OPDA170*	DTA170G500	-	23

* These models of support stands can be made of a steel alloy, without losing their weight and reference characteristics.

MOVEMENT

BRIDGE BEAMS



M184-2200

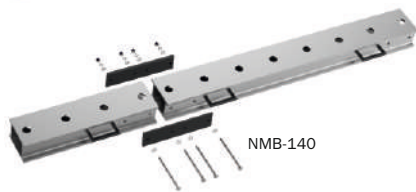

NMB-140

They are designed for moving roller skids on them and are the main supports when lifting, holding and lowering the rolling stock of the ENERPRED jacks.

Model	Length, mm	Width, mm	Height, mm	Weight, kg
M140-1100	350	1100	140	45
M140-2200	350	2200	140	89
M140-3300	350	3300	140	133
M184-1100	350	1100	184	65
M184-2200	350	2200	184	130
M184-3300	3300	275	175	128
NMB-140	Set for connecting bridge beams		140	18
NMB-184			184	21

ROLLER TROLLEYS



Rt75

They are designed to move the rolling stock in the transverse direction along the bridge beam and are the supporting and mobile platform for the ENERPRED jacks.

Model	Height, mm	Weight, kg
Rt75	117	44
RT60/120P	140	64

SPLASH BEAMS



RB-3
(in the folded state)



RB-3
(in working order)

Are intended for connection of two roller carriages ENERPRED with transverse moving of a rolling stock.

Model	Min. Length in working condition, mm	Max. Length in working condition, mm	Weight, kg
RB-3	1190	1830	19
RB-4	1500	2800	27

CYLINDERS OF DISPLACEMENT



CP15G320FG

WHEEL PAIR PULLEY



TKP50



DGA10P150

MOUNTING PLANT



UGP50-300

Transport trolley for locomotives



TTL25



TTL25 truck under the locomotive

Model	Carrying capacity, tons	Speed, max, km/h	Diameter of locomotive wheel, mm	Dimensions (BxLxH), mm	Weight, kg
TTL25	25	15	1250	1940x1310x280	464

Trolley for transportation of wagons



TTV45

It is designed for the transverse movement of a roller carriage on the bridge beam ENERPRED.

Hydraulic repositioning - automatic repositioning of the displacement cylinder on the bridge beam.

Model	Force pushing/retracting, ton	Stroke of a rod, mm	Weight, kg
CP15G350-575	16/91	320	24
CP30G320FG	33/20	320	40

It is intended for installation of a rolling stock in a track in cases when it has been put on a crest of a wheel during lowering on rails.

Model	Force pushing, ton	Rod stroke	Dimensions (BxLxH), mm	Weight, kg
TKP-1500	10	150	650x685x110	11

* Cylinder displacement CPU15G350-575 is not included in the scope of supply

It allows neatly aligning the light rail transport (already raised on the ENERPRED jacks) with respect to the rail track and moving it in the transverse direction. After reaching the correct position with an easy rail transport, it is lowered onto the rails.

Model	Effort of horizontal displacement, ton	Transverse displacement, mm	Dimensions (BxLxH), mm	Weight, kg
UGP50-300	9	300	373x980x153	70

Used to output locomotives to the nearest repair location in case of jamming or fracture of the locomotive axis. For convenient carrying, the trolley structure is collapsible. The heaviest element (power beam) has 4 handles for carrying. To facilitate and accelerate the assembly of the cart in its design, threaded connections are excluded.

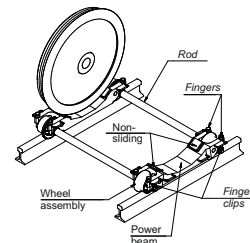

Weight of structural elements:

- Wheel assembly - 33 kg - 4 pcs.
- Power beam - 100 kg - 2 pcs.
- Rod - 60 kg - 2 pcs.
- Removable cover - 1,3 kg - 4 pcs.
- Fingers - 1,2 kg - 8 pcs.
- Finger of the lock - 0,15 kg - 4 pcs.
- Total: 464 kg

Tool for fastening trolleys p. 74

Используется для транспортировки железнодорожных вагонов до ближайшего места ремонта в случае выхода из строя колесных пар или всей вагонной тележки.

Model	Carrying capacity, max, ton	Speed, max, km/h	Weight trolley, kg	Weight of power, beam, kg	Weight of the removable frame, kg
TTV45	45	40	748	140	771

Carriage fixing device

Series PHT ...
Load capacity – 8 tons

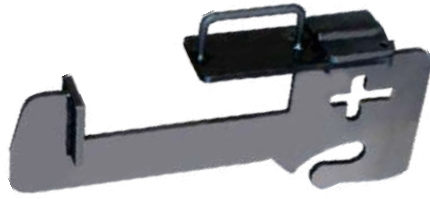

Model: PHT

Carriage fixing device is designed for suspending the carriages to the body of electric locomotives VL-80, VL-60.



Model	Rated load capacity, tons	Weight without string, kg	Weight with string, kg
PHT	8	12,5	24

Aluminum trolley jacks

Series DA...
Load capacity – 25 ton
Stroke of extension screw – 500 mm



Model: DA25M500TA

Independent aluminum trolley jack DA series with extension screw is used during repair and restoring works in locomotive and car shops and during installation and dismantling works, repair works in different industrial sectors.

Advantages of the trolley jacks:

- Independence;
- Floating support to reduce radial load on the jack;
- Unique construction of extension screw with substantial stroke;
- Made of high-strength light alloy which provides its mobility and lightness.

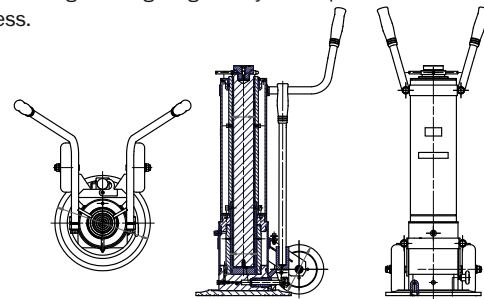

Model	Load capacity, ton	Rated pressure, Bar	Rod stroke, mm	Extension screw stroke, mm	Min height of pickup, mm	Tank volume, cm ³	Рабочий объем, см ³	Pivot angle of handle, deg.	Overall dimensions (BxLxH), mm	Capacity on handle, kgf	Weight, kg	Pump capacity, cm ³ /stroke
DA25M500TA	25,1	490	100	500	700	612	502	55	538x520x1219	45	45	3,98

Mobile jacking installation

Series UDP...
Load capacity – 100 ton



Model: UDP100

The installation is designed to lift locomotives of KZ4AC and KZ8 series, their holding in the upper position to gain access for the equipment dismantling in the area below the frame.

The installation consists of four jack columns installed in pairs from the both sides of the railway.

The electric motor torque is transferred to the worm gearbox and further to the lead screw; it causes lifting or lowering of the locomotive. Both synchronous and separate operation of the jack columns is possible. Emergency stop of the jack columns is provided with complete voltage shutdown by a single button. The columns can be controlled both from the main electric cabinet or remote control and from an electric cabinet located on each separate column. There is light indication of the installation current state.

In case of emergency there is a possibility to lower the carriages with a manual lowering device.

When the carriage reaches the limit positions, the jack columns electric motors are shut down automatically what protects the installation from damage.

Hydraulic carriages
 TM Rikline page 111

The installation is equipped with 4 hydraulic carriages TGR 3.5/195

Model	Load capacity, ton	Load capacity of the 1st rack, ton	Number of racks, pcs.	Min height of pickup (with support), mm	Max height of pickup (with support), mm	Lifting speed, max, mm/min	Electric motor, kW/rpm	Voltage, V	Range of ambient temperatures, °C	Overall dimensions (BxLxH), mm	Weight of one rack, t	Weight, t
UDP100	100	25	4	800 (1100)	3000 (3300)	336	7,5 / 1500	380	from -5 to +30	1328x1150x3535	2,1	8,4

Equipment for rail string tensioning

Series UG... Capacity — 71,6 ton

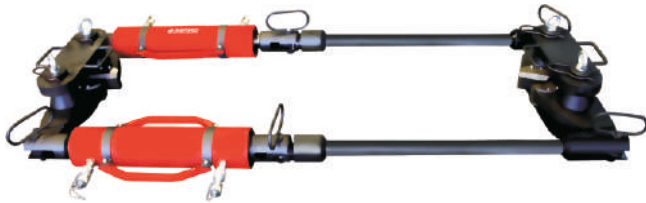

Model: UG70/400



Model: UG70V/400

The equipment is designed for tensioning of the rails up to 1,200 m with temperature compensation up to 25 °C.

— The modular design provides easy mounting and dismantling of the device and its transportation by individual elements;

— Hydraulic cylinder is equipped with quick-disconnect couplers to avoid a loss of hydraulic oil during disconnection from the source of pressure;

— High performance is achieved by using pumps with electric or gasoline drive.

Tensioner UG70/400 is used for the construction of new railways.

— Model UG70V / 400 is designed to work on the Operativnyh stretches of road. It does not violate the envelope, allowing skip the rolling stock;

The hydraulic tensioner UG70V / 400 has two options assembly without arches and arch for mounting drilling and carved machines rail.

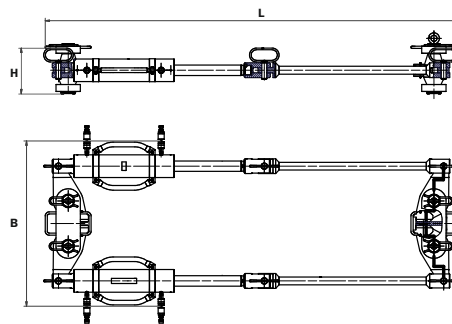

Model	Tension capacity, ton	Pulling force with arches, ton	Stroke, mm	Oil working capacity, cm ³	Dimensions (BxLxH), mm	Weight, kg	Recommended pump
UG70/400	71,6	—	380	3800	964x2329x337	310	NRG-7080R, NBR...
UG70V/400	71,6	20	380	3800	1954x3393x410	623	NRG-7080R, NBR...

Rail lifting jacks

Series DJ., DJA... Capacity — 12-30 ton Pressure — 520-700 Bar



Model: DJA15P200, DJA20M300, DJ30P300

Provide safe and rapid uplift of the track panels and turnouts for the average and major repairs as well as current maintenance of railway track.

— Models with load capacity of 20 ton can be used for work on the tracks with ferroconcrete sleepers, as well as to raise the rolling stock and other facilities;

— Series DJA... has an built-in pump, series DJ are powered by an external pump;

— Cylinders Series DJA ... P.. are with limiting dimensions that allows not to remove them when the rolling stock passes by (when the rolling cylinder passes unload the cylinder to set the stroke to the original position)

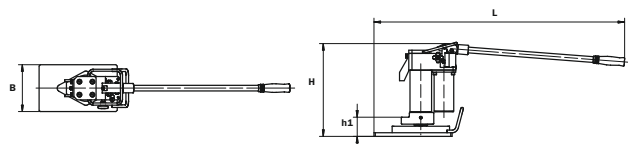

Model	Capacity, ton	Stroke, mm	Height of the pick-up point, h1, mm	Pressure, Bar	Oil working capacity, cm ³	Dimensions (BxLxH), mm	Weight, kg
DJA12P160	12	160	70,5	600	314	180x952x352	25
DJA15P200	15	200	72	520	565	180x952x388	25
DJA20P160	20	160	73	630	499	180x952x354	26
DJA20M300**	20	300	70	630	930	180x923x540	32,8
DJ30P300*	30	300	72	700	1507	224x444x490	50

* — recommended pump NRG-7020

** — gravity return of the stroke

Railway leveler

**Series RGA...
Capacity — 10-12 ton**

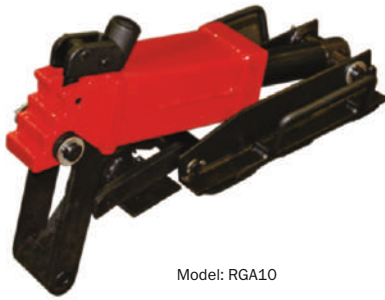

Model: RGA10

It is designed for lining of the track panels and turnouts, laid on wooden and concrete sleepers, during repairs and maintenance of the railroad. Machine for track lining eliminates the need for a preliminary loosening of the ballasting at the butt ends of the sleepers and digging it out from the cribs. To increase stability on the loose ground a removable base plate is installed at the U piece.

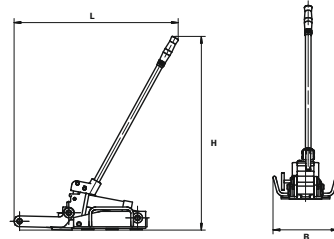

Model	Capacity, ton	Stroke, mm	Oil working capacity, cm ³	Dimensions (BxLxH), mm	Weight, kg
RGA10	10	100	200	240x495x186	23
RGA12	12	160	314	240x551x194	26,8

Rail gap spreader

**Series RRA...
Force — 22,6 ton
Spreading range — 100 mm**



Model: RRA-04-KR140

Model: RRA-35

It is designed for lineal shifting of the rail-track or rails to restore normal gaps between the rails, damaged as a result of track displacement by rolling stock. The spreader is free to move along the rails with special wheels to the next joint providing for quick and easy work.

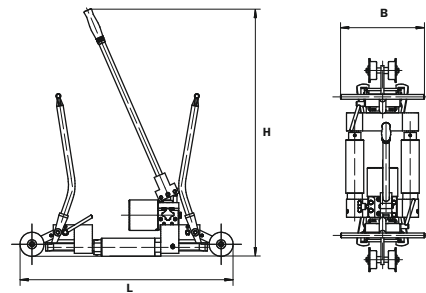

Model	Capacity, ton	Maximum spreading, mm	Dimensions (BxLxH), mm	Weight, kg	Type of rail
RRA-04	22,2	100	280x710x825	38	R65
RRA-04-KR140	22,2	100	320x728x837	46	Kr140
RRA-35	35	125	350(1875)*x1300x382(920)*	83,4	P65

* Dimensions in brackets are installed with handle and rod

Reincapacityd concrete beam expander

**Series PRB...
Pressure — 700 Bar**



Model: PRB10

It is designed to obtain the required distance between ferroconcrete (f / c) beams when laying track panel. The device is installed between joists and preads the beams pumping hydraulic fluid into the cylinder chamber. The stroke returns with the pressure relieve by spring capacity.

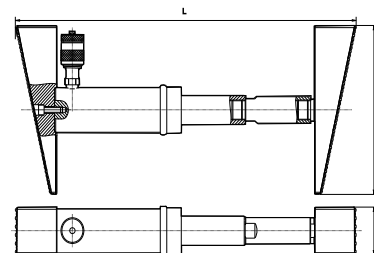

Model	Tension capacity, ton	Spreading in a single cycle, mm	Dimensions (BxLxH), mm	Weight, kg	Recommended pump
PRB10	10	100	65x420x230	12,8	NRG-7010

Hydraulic sleepers expander



Series RRSH. . .
Capacity — 11,1 ton



Model: RRSH10

It is designed to rearrange and readjust the distance between the sleepers. It provides for the mechanization of operations at the current maintenance and repair of the road.

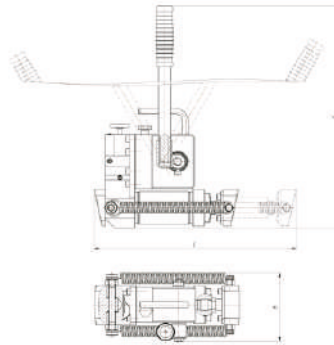

Model	Capacity, ton	Pressure, max, Bar	Stroke, mm	Dimensions (BxLxH), mm	Weight, kg
RRSH10	11,1	700	125	140x313x1304	19,3

Hydromechanical torque wrench with built-in nut splitter



Series GMG. . .
Capacity — 20 ton



Model: GMG-180K

It is a hydraulic car driven by an internal combustion engine. It is designed for tightening and loosening butts nuts, expander nuts, terminal bolts of JBR and KB type of bolting and for removal of damaged or rusted nuts. Hydromechanical torque wrench with built-in nut splitter is used for current maintenance and repair, as well as for assembly and disassembly of the rail track panel with gage of 1520 mm for R50, R65, R75 types of the rails

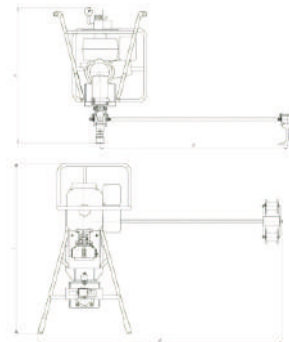

Model	Capacity, ton	Dimensions range of the cut nuts, mm	Max pressure in the hydraulic system, Bar	Torque max, nm	Rated speed of the hydraulic motor take-off shaft	Dimensions (BxLxH), mm	ICE type, gasoline	Engine rating, kW	Weight (dry without support attachment group), kg
GMG-180K	20	32 ... 41	500	730	100	1200x450x600	Honda	6,6	82

Hydraulic rail-bender

Series RG...
Bend capacity — 35,2 ton



Model: RG 3550

It is designed for bending of the rails directly at the point of installation by the required form of section (for station sites, open pits, mines).

- The minimum bend radius is 3 m;
- Double extra strong welded steel frame;
- Equipped with a carrying handle;
- Single general purpose bending punch.

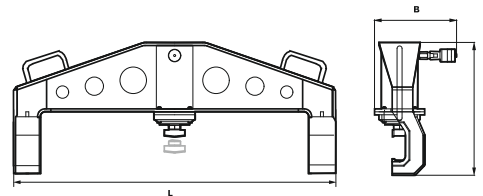

Model	Capacity, ton	Stroke, mm	Minimum bend radius, m	Rail type	Dimensions (BxLxH), mm	Weight, kg	Recommended pump
RG3550	35,2	150	3	R18, R24, R33, R43, R50	280x1110x456	71,5	NRG-7020

Wheeled jack



Model: DG50P500P

Wheeled jacks Enerpred are designed for quick and safe lifting of locomotives in the shop without any additional means during repair works and maintenance. Control is carried out through the radio channel from the remote control or manually. It is possible to construct a system of wheeled jacks of 4, 6 or 8 pieces.

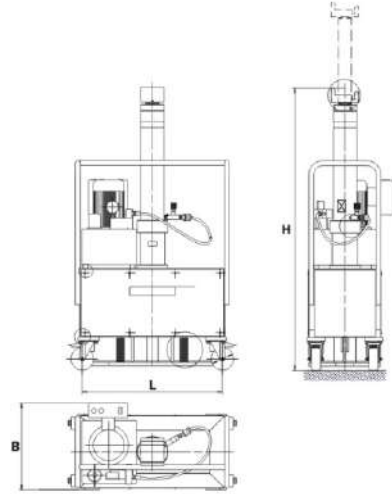

Peculiarities and advantages of the wheeled jacks construction:

Remote control over the jack through the radio channel:

- a worker is not bound to a particular place;
- labor saving – it is maintained by a single person;
- convenience of control over the lifting process, precise positioning of a locomotive;
- safety of lifting operation;

Clamping nut of the jack:

- possibility of load fixing in the raised position for a long time;
- safety assurance for operation with the lifted load;

Full design (jack+pumping station+carriage):

- excludes necessity to use additional equipment for lifting operation;
- independence – there is no binding to the workshop sector;

Swivel wheels of the carriage:

- allows quick and precise installation of the wheeled jack in the desired position;

Floating support:

- reduces radial loads on the jack rod;

Spring-actuated column:

- allows the installation to raise on the springs providing the possibility of free movement (rolling) on the wheels;
- base of the spring-actuated column is designed to increase the load distribution area while lifting the locomotive;

Throttle built in the hydraulic system:

- provides smooth lowering of the load.



Model	Rated load capacity, ton	Rated pressure, Bar	Rod stroke, mm	Tank useful capacity, cm ³	Range of ambient temperatures, °C	Voltage, V	Motor power, kW	Dimensions (BxLxH), mm	Weight, kg	Pump station
DG50P500P	56	700	500	10000	from - 30 to + 40	220	220	500x933x1500	316	NEE-1, 6I10F1-Ru



Small gear puller

Series SSMH...
Capacity — 202 ton



Model: SSMH200

Small gear puller is designed to remove the small gear of the drive motor.

- Equipped with a variety of optional fittings;
- Electric locomotives VL80, VL65, VL60k, VL60PK, OPE-1;
- Diesel-electric locomotives TEM, CHME, TE-10, TEM-2.

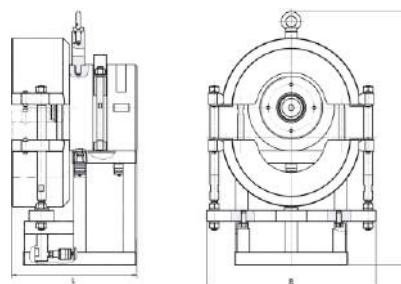

Model	Capacity, ton	Stroke, mm	Lower bracket clamping capacity, ton	Dimensions (BxLxH), mm	Weight, kg	Recommended pump
SSMH200	202	60	5,6	550x405x819	371	NEE-1,6I10T1

Cylinder for display of the wheel-motor units of locomotives

Series DG...P...KMB
Capacity — 35,8 ton
Pressure — 700 Bar



Model: DG35P100KMB

It is designed for integration into the system for display of the wheel-motor units of locomotives during diagnostics and repair of locomotive drive engine bearings in the loco depot. It is equipped with a set of three safety brackets which ensure unlimited hold-up of the load and eliminate its emergency drop in case of the hydraulic system failure. It is equipped with a floating fulcrum block, made of high-strength steel with a special heat treatment, which compensates radial load on the stroke (up to 25% of the total load) and provides reliable and safe operation.

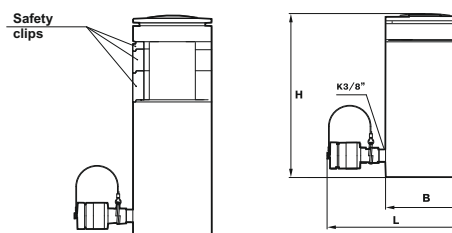

Model	Capacity, ton	Stroke, mm	Oil working capacity, cm ³	Height of the safety brackets			Dimensions (BxLxH), mm	Weight, kg
				1	2	3		
DG35P100KMB	35,8	100	502	43	33	23	108x188x225	15

Absorbing devices removal tools

Series PPA...
Capacity — 20-56 ton
Pressure — 700 Bar



Model: PPA1

Model: PPA3

It is designed for removal of the cushioning units of SH-1-TM, SH-2-8, SH-2-T and SH6-T0-4U types of the wagons and locomotives for repair work. The device helps to reduce the time required for removal of cushioning units installed at the automatic coupling of railway rolling stock, to increase efficiency and safety.

Two models:

PPA1 with single 55 mm wide wedge can be used for removal of cushioning units of the freight wagons and passenger cars; PPA2 with two 45 mm and 55 mm wide wedges can be used for electric locomotives VL65, VL80, VL85 and other locomotives.

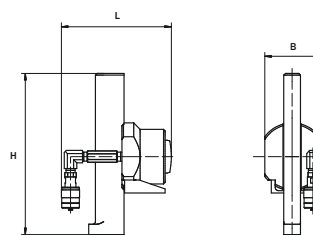

Model	Capacity, ton	Stroke, mm	Oil working capacity, cm ³	Dimensions (BxLxH), mm	Weight of hydraulic cylinder, kg	Wedge weight, kg	Recommended pump
PPA1	20	20	100,5	107x250x310	6,8	4,1	NRG-7004A
PPA2	20	20	100,5	107x250x310	6,8	3,3; 4,1	NRG-7004A
PPA3	56	50	393	152x145x266	11,4	—	HPF-7010

Machines for building up boxes

Series UNB...
Capacity – 35 ton



Model: UNB35-4

Device for axle-box build up welding is used during repair of parts and components of the railway rolling stock and designed for stationary welding of seats for the axle equipment.

To operate the unit on complete:

- Multi-port valve KMH4 + BRSD001 coupling half in quantity of 1.;
- High pressure hoses RVD2000 - 5. (4 pcs. - From installation to multiway valve, 1 pc. - From multi-port valve to the pump);
- Hydraulic hand pump - GNR-7020 - 1 piece.

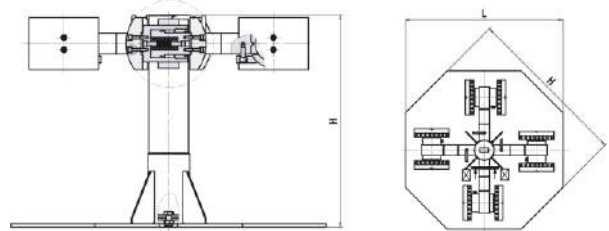

Model	Capacity, ton	Rated pressure, Bar	Stroke, mm	Axle-box bore diameter	Number of seat, pcs.	Axle equipment turning angle, degree	Oil working capacity, cm ³	Ambient temperature range, °C	Dimensions (BxLxH), mm	Weight, kg
UNB35-4	35,8	700	30	250	4	90	150	-30 to +40	940x940x607	191

Cup nut loosening tool

Series PTG. . .
Pressure – 700 Bar



Model: PTG155

The tool helps to unscrew problem cup nuts, screwed with adhesive sealant in the wheel set axle of railway cars. It is used in conjunction with the wrench GKG1000

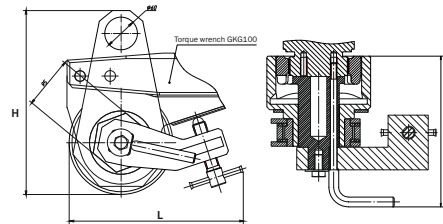

Model	Nut width across flats, mm	Torque, kg-m, max	Dimensions (BxLxH), mm	Weight with torque wrench, kg	Weight, kg	Recommended pump
PTG155	155	1000	221x305x337	36,6	23	NEE...NEA...

Press for pressing-out of railroad engine pivot bushings

Series PVL...G...
Capacity – 56 tons



Model: PVL50G500

Press is designed for pressing-out and pressing-in of railroad engine pivot bushings and other types of works.

Accessories may be produced according to individual parameters of the Customer.

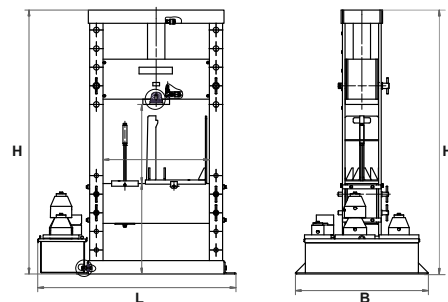

Model	Capacity, ton	Rod stroke, mm	Overall dimensions of operating space (HxB), mm:		Overall dimensions (BxLxH), mm	Weight with accessories set, kg	Recommended pump
			max	min			
PVL50G500	56	500	1295x800	315x800	1000x1501x1985	542	NRG-7080R

Polyspast blocks

Series B...
Capacity – 1,25-3,2 ton



Model: B-3,2

It is designed to double the pulling capacity of the crab winches and other pulling and lifting mechanisms equipped with pulling rope / cable.

Model	Capacity, ton	Maximum rope diameter, mm	Weight, kg
B-1,25	1,25	5,6	3,6
B-3,2	3,2	8,3	4,5

Coffing hoists

Series LR...
Pulling capacity – 0,63-1,6 ton
Travel – 3-9 m



Models: LR-1,6/3, LR-0,63/6

They are designed to move goods in a horizontal direction, string wires, pull out stuck cars and for other operations in industry as well as in household use. One person can easily move cargo weighing up to 1.6 tones. All models are equipped with a free handle. LR-1,6/... models have a screwed telescopic handle with adjustable length.

Model	Pulling capacity, ton*	Travel, m	Diameter, mm	Maximum capacity on the handle, kg	Dimensions (BxLxH), mm	Weight, kg
LR-0,63/3	0,63	3	5,6	27	130x760x105	6,6
LR-0,63/6	0,63	6	5,6	27	130x760x105	7
LR-0,63/9	0,63	9	3,6	27	130x760x105	7,4
LR-1,6/3	1,6	3	8,3	35	155x1250x145	12,2
LR-1,6/6	1,6	6	8,3	35	155x1250x145	13
LR-1,6/9	1,6	9	8,3	35	155x1250x145	13,8
LR-1,6/12	1,6	12	8,3	35	155x1250x145	15,1

* As the filling drum rope traction decreases

Gantry crane

Series EKP...
Capacity – 1 ton



Gantry cranes are classified as labor saving tools for cargo handling and they are widely used at the enterprises with different turnover, designed for cargo lifting, lowering and moving in the shops and at the sites.

Types of possible operations:

- Loading and unloading;
- Replacement of parts and components of machines;
- Any type of repairs of the cars and machines;
- Operation in storehouse facilities

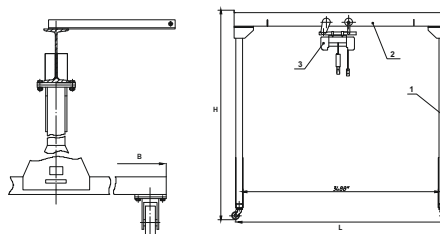

1 - rack;
2 - beam;
3 - pulley;
4 - control panel.

- Cranes consist of the rack and pulley. Crane pulley is controlled by a pendant control panel;
- The advantage of this crane is not only light weight and dimensions but also availability, and low cost in comparison with other lifting equipment;
- Cranes of this type move with help of mounted wheels. Two wheels of four are equipped with brake. Even for one person it is not a problem to move the crane by hand. The other convenience of the cranes of this type is a possibility adjustment of the height of lift.

Model	Capacity, ton	Power supply	Height of lift H1, mm	Gantry width, mm	Gantry height, mm	Dimensions (BxLxH), mm	Weight, kg
EKP1	1	380 V	2600	3488	3460	1200x3820x3740	558

Pumps selection table

Choose the pump for a particular instrument according to the following directions:

1. Follow the recommended compatibility of pumps with cylinders (see selection table).
2. Choose a pump basing on the compliance of technical characteristics of the pumps (see selection table) and tools (note that the displacement volume of the Oil of the tool (s) and hose (s) must be less the effective volume of the pump tank). If you need more information regarding the pump or recommendations about the proper completing units of the full hydraulic system, please contact your nearest representative of CJSC "TD" Enerpred."

Stroke, mm	Capacity of the cylinders DU..P, DG..P, DG..P..G, DN, DO..P, DP..P, DS, DGA..P, DGA..P..G, ton																
	5	8	10	15	20	30	35	50	60	100	140	150	200	300	400	500	600
15																	
50																	
100																	
150																	
200																	
250																	
300																	
360																	
400																	
500																	

Pump	NRG-7004A	NRG-7010	NRG-7020	NRG-7035	NRG-7080	NRG-7160	NER...A
Useful oil capacity, cm ³	350	800	1600	3500	8000	16000	>16000

Stroke, mm	Capacity of the cylinders DU..G, DG..G, DO..G, DP..G, CS, DT, ton														
	5	8	10	15	20	35	50	60	100	150	200	300	400	500	600
50															
100															
150															
200															
250															
300															
400															
500															
600															
800															
1000															
1250															

Pump	NRG-7020R	NRG-7035R	NRG-7080R	NRG-7160R	NER..I
Useful oil capacity, cm ³	1600	3000	8000	16000	>16000

Hydraulic foot pump

Series NGN...
Reservoir — 2000 cm³
Pressure — 700 Bar

- Reliable source of pressure for hydraulic tool, independent on external power supply;
- Has the ability to operate with double-acting hydraulic tool with integrated hydraulic valve.



Model: NGN-7020

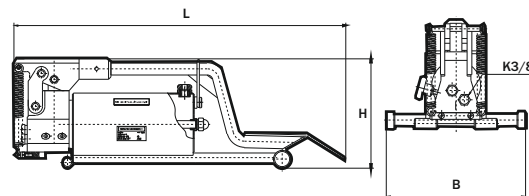

Model	Nominal oil capacity, cm ³	Useful oil capacity, cm ³	Pressure, Bar		Volume per stroke, cm ³		Max. handle effort, kgs	Dimensions (BxLxH), mm	Weight, kg
			1 stage	1 stage	1 stage	2 stage			
NGN-7020	2000	1500	12	700	12	1,5	45	240x571x188	8

Manual hydraulic pumps for equipment with spring or gravity retraction

Series NRG...

Nominal oil capacity — 400-18000 cm³

Pressure — 700-1000 Bar



Model: NRG-7020



Model: NRG-7004A



Model: NRG-7004

Reliable source of pressure for hydraulic tools, independent of external power source.

— All pumps are equipped with built-in safety valves, which are set to nominal pressure;

— NRG -7004A - lightweight model with aluminum body;

— NRG-10035 - Model with an aluminum body, operates with pressure of 1000 Bar;

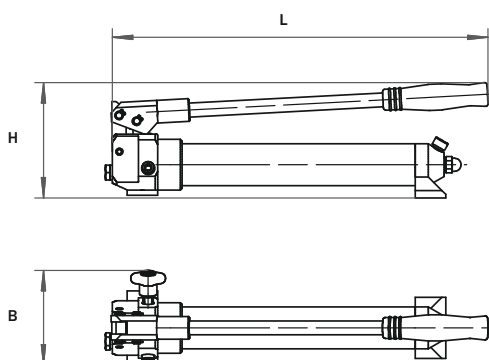

Model	Nominal oil capacity, cm ³	Useful oil capacity, cm ³	Pressure, Bar		Volume per stroke, cm ³		Dimensions (BxLxH), mm	Weight, kg
			1 stage	2 stage	1 stage	2 stage		
NRG-7004	400	350	1,38	70	7	1	142x343x127	5,5
NRG-7004A	400	350	1,38	70	12,9	1	110x391x140	3,2
NRG-7010	1000	800	1,38	70	13	2,8	136x710x152	8,2
NRG-7010A	1000	800	2	70	15,38	2,8	131x590x180	5,6
NRG-7020	2000	1600	1,38	70	13	2,8	148x580x189	12,4
NRG-10035	3500	3000	2	100	21,4	1,3	130x670x208	10,5
NRG-7035	4000	3500	1,38	70	13	2,8	148x714x189	15,5
NRG-7080	10000	8000	2,75	70	113	4	310x715x320	22,2
NRG-7160	18000	16000	2,75	70	113	4	389x700x320	29,4

Manual hydraulic pumps for equipment with hydraulic retraction

Series NRG...R

Nominal oil capacity — 2000-18000 cm³

Pressure — 700 Bar





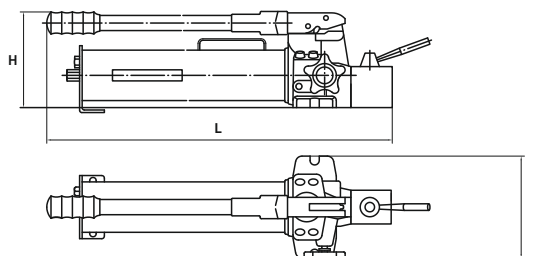

Model: NRG-7035R

— NRG...R models have built-in hydraulic control valves allowing to work with double-acting tools.

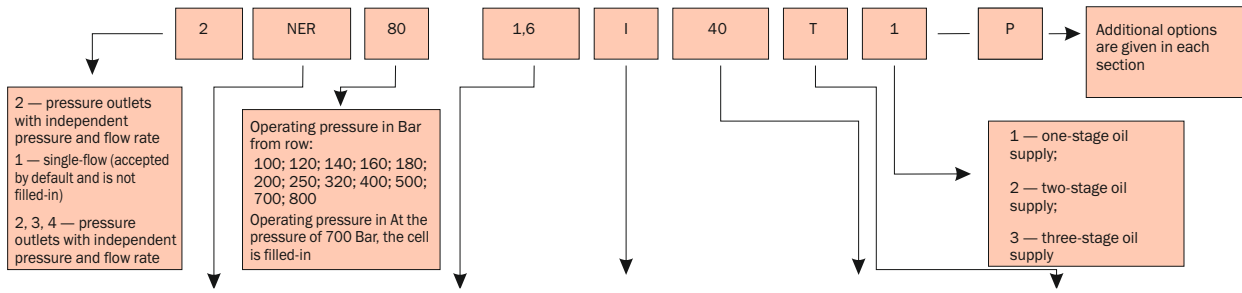

Model	Nominal oil capacity, cm ³	Useful oil capacity, cm ³	Pressure, Bar		Volume per stroke, cm ³		Max. handle effort, kg	Dimensions (BxLxH), mm	Weight, kg
			1 stage	2 stage	1 stage	2 stage			
NRG-7020R	2000	1600	13,8	700	13	2,8	50	148x635x189	15,8
NRG-7035R	3500	3000	13,8	700	13	2,8	55	148x795x189	18
NRG-7080R	10000	8000	27,7	700	113	4	50	310x715x340	22,8
NRG-7160R	18000	16000	27,5	700	113	4	50	389x700x340	30

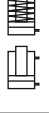
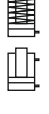
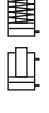

Type of station	Flow rate, L/min	Type of control valve	Tank volume, L	Power supply	Type of tool
NER with manual control valve	0,5	A; I	4, 8	F; T	
	0,8	A; I	8, 10, 20, 40	F; T	
	1,1	A; I	8, 10, 20, 40	F; T	
	1,6	A; I	8, 10, 20, 40, 63, 100	F; T	
	2,8	A; I; ADD*	20, 40, 63, 100	T	
	6,0	A; I; ADD*	40, 63, 100, 160	T	
	10,0	I; P; PKK; PKZK; PK...K	40, 63, 100, 160	T	
	18,0	P; PKK; PKZK; PK...K	160, 200, 250, 400	T	
	25,0	P; PKK; PKZK; PK...K	160, 200, 250, 400	T	
	NEE with electric drive and solenoid control valve	0,5	G; I	4, 8	
0,8		G; I	8, 10, 20, 40	F; T	
1,1		G; I	8, 10, 20, 40	F; T	
1,6		G; I	10, 20, 40	F; T	
2,8		G; I; ADD	20, 40, 63, 100	T	
6,0		G; I; ADD	40, 63, 100, 160	T	
10,0		I; K; AKK; AKZK; AK...K	40, 63, 100, 160	T	
18,0		K; AKK; AKZK; AK...K	160, 200, 250, 400	T	
25,0		K; AKK; AKZK; AK...K	160, 200, 250, 400	T	
NEA with electric drive and solenoid control valve operating in automatic mode		0,5	G; I	4, 8	F; T
	0,8	G; I	8, 10, 20, 40	F; T	
	1,1	G; I	8, 10, 20, 40	F; T	
	1,6	G; I	10, 20, 40	F; T	
	2,8	G; I	20, 40, 63	T	
	6,0	G; I	40, 63, 100	T	
	10,0	I	100	T	
VNER with manual control valve, with explosion-proof motor	1,6	I	10, 20, 40, 63	T	
	2,8	I	20, 40, 63	T	
	5,0	I	40, 63, 100	T	
	10,0	I	100	T	
NBR with petrol drive	0,4	A; I	4, 8	—	
	0,8	A; I	4, 8	—	
	1,2	A; I	4, 8	—	
	1,6	A; I	8, 10, 20, 40, 63	—	
	2,4	A; I	20, 40	—	
	5,0	A; I; P	40, 63, 100	—	
	10,0	A; I; P; PKK; PKZK; PK...K	100, 160	—	
	10,0	A; K; KK; KZK; K...K	100, 160	—	
NDR with diesel drive, electric starter and solenoid control valve	5,0	A; I; P	40, 63, 100	—	
	10,0	A; I; P; PKK; PKZK; PK...K	100, 160	—	
NDE with diesel drive	10,0	A; K; KK; KZK; K...K	100, 160	—	
NPR with pneumatic drive and manual control valve	0,5	A; I	4, 8	—	
	1,1	A; I	8, 10	—	
	1,6	A; I	10, 20	—	
	2,1	A; I	40	—	

*Control valves are manufactured under the special order

A — unloading crane (operating stroke — return);

G — 2-position slide valve (operating stroke — return);

I — 3-position slide valve (operating stroke — holdup — return);

ADD — two (3 and more D4D) 3-position slide valves for several jacks (operating stroke — holdup — return);

P — flat rotary control valve;

K — control valve;

AKK — two control valves with normally closed neutral and unloading crane, for connection of two independent hydraulic cylinders of double action (pressure up to 700 Bar);

AKZK, AK...K — for control over three and more hydraulic cylinders of double action (pressure up to 700 Bar);

B — Without distributor



single-acting

F — 220 V, 50 Hz, 1-phase



double-acting

T — 380 V, 50 Hz, 3-phase

With manual valve

Series NER...A...
Pressure — 700 Bar



Model: NER-1,6A10T1-Zpk

Pumps of the series NER...A are a simplified version with the minimum complete set for manual operation. Equipment is controlled by manual relief valve set to a pump. It is equipped with a collector rivet nut with threaded seats (K3 / 8") for connection of pressure and discharge hoses and seat (K3 / 8") for connection of the pressure gauge with adapter. Pressure control valve group, pressure gauge and plug connector are not included in the scope of supply of the basic equipment. If these completing units of pump are necessary, as well as the collector threaded rivet nuts to connect several devices, they must be ordered separately. The stations are used with single-acting hydraulic equipment /tools that do not require retention in a loaded position (cutting tools, pullers, pipe benders, etc.).

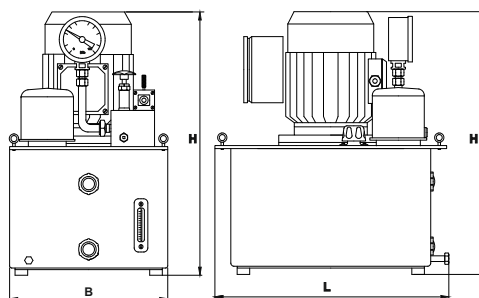

Model	Output flow rate, l/min	Tank volume, l	Power supply	Electric motor power, kw	Dimensions (BxLxH), mm	Weight*, kg				
NER-0,8A8F1	0,8	8	220V, 50 Hz	1,1	420x250x525	36				
NER-0,8A10F1		10			420x300x530	37				
NER-0,8A20F1		20			420x300x610	38				
NER-0,8A40F1		40			560x390x660	51				
NER-1,1A8F1	1,1	8		220V, 50 Hz	1,5	420x250x525	37			
NER-1,1A10F1		10				420x300x530	38			
NER-1,1A20F1		10				420x300x610	39			
NER-1,1A40F1		10				560x390x660	52			
NER-1,6A10F1	1,6	10			380V, 50 Hz	2,2	420x300x530	39		
NER-1,6A20F1		20					420x300x610	40		
NER-1,6A40F1		40					560x390x660	53		
NER-0,8A8T1	0,8	8				380V, 50 Hz	1,1	420x250x525	36	
NER-0,8A10T1		10						420x300x530	37	
NER-0,8A20T1		20						420x300x610	38	
NER-0,8A40T1		40						560x390x660	51	
NER-1,1A8T1	1,1	8					380V, 50 Hz	1,5	420x250x525	36
NER-1,1A10T1		10	420x300x530						37	
NER-1,1A20T1		20	420x300x610						38	
NER-1,1A40T1		40	420x300x530						52	
NER-1,6A10T1	1,6	10	380V, 50 Hz					2,2	420x300x530	39
NER-1,6A20T1		20		420x300x610					40	
NER-1,6A40T1		40		560x390x660					53	
NER-2,8A20T1	2,8	20		380V, 50 Hz				3,0	420x300x620	48
NER-2,8A40T1		40							560x390x707	61
NER-6A40T1	6,0	40			380V, 50 Hz			7,5	560x390x730	88
NER-6A63T1		63							560x390x870	97
NER-6A100T1		100							650x620x920	110

* Weight of the pum without oil;

Feeding oil for pumps is delivered on customer request.



Extras:

- R — adjustment and pressure relief valve;
- T — thermometer;
- M — gauge;
- SH — plug-and-socket connector;
- K — the wheels on the tank;
- B2 (B3, B4) - collector threaded rivet nuts for parallel connection of 2 (3 or 4) simultaneously operating hydraulic tools;
- Zk — protective frame;
- Zpk — is a protective half-shell;
- Dr — throttle control of the supply;
- Dr — throttle control of the supply;
- A — adapter;
- Du — level sensor.

Model: NER-2,8A20T1-MKZSHZk
 In protective frame, with gauge and plug-and-socket connector

With manual valve

Series NER...I(P,K)
Pressure — 700 Bar



Model: NER-1,6I10T1-Zpk

Pump of the series NER...I... is a complete package for manual operation and control. It is equipped with a vibration-resistant gauge, safety valve, pressure control valve group, 2m power cable with plug-and-socket connector. Hydraulic equipment is controlled with help of the manual three-position valve mounted on the pump. Motor control buttons (start-stop) are located on the cover of the electromagnetic starter with thermal relay. Manual three-position valve of the series I... (Model GR-3IR-1) operates in "stroke-hold-back" mode (cylinders, hydraulic cylinders, pipe benders, pressure machines, etc.). Pumps are used with all types of hydraulic equipment /tools both single and double-acting. Optional units are frequency converter for the motor frequency regulation, thermometer, electric heater with a thermostat, radiator for cooling the drain flow, gauge with digital display of pressure (capacity) and wheels to roll the station.

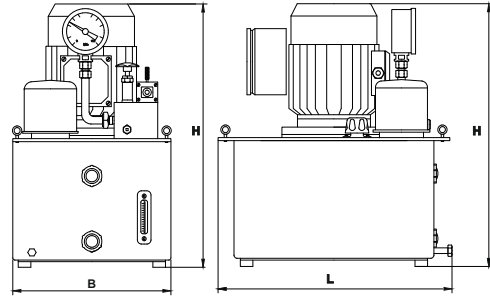

Model	Output flow rate, l/min	Tank volume, l	Power supply	Electric motor power, kw	Dimensions (BxLxH), mm	Weight*, kg	
NER-0,8I8F1	0,8	8	220V, 50 Hz	1,1	420x250x525	36	
NER-0,8I10F1		10			420x300x530	37	
NER-0,8I20F1		20			420x300x610	38	
NER-0,8I40F1		40			560x390x660	51	
NER-1,1I8F1	1,1	8		1,5	420x250x525	37	
NER-1,1I10F1		10			420x300x530	38	
NER-1,1I20F1		20			420x300x610	39	
NER-1,1I40F1		40			560x390x660	52	
NER-1,6I10F1	1,6	10		2,2	420x300x530	39	
NER-1,6I20F1		20			420x300x610	40	
NER-1,6I40F1		40			560x390x660	53	
NER-0,8I8T1		8			420x250x525	36	
NER-0,8I10T1	0,8	10		1,1	420x300x530	37	
NER-0,8I20T1		20			420x300x610	38	
NER-0,8I40T1		40			560x390x660	51	
NER-1,1I8T1		8			420x250x525	36	
NER-1,1I10T1	1,1	10	1,5	420x300x530	37		
NER-1,1I20T1		20		420x300x610	38		
NER-1,1I40T1		40		560x390x660	52		
NER-1,6I10T1		10		420x300x530	39		
NER-1,6I20T1	1,6	20	2,2	420x300x610	40		
NER-1,6I40T1		40		560x390x660	53		
NER-1,6I63T1		63		560x390x800	57		
NER-1,6I63T1		100		680x620x700	80		
NER-1,6P40T1	2,8	40	3,0	560x390x660	52		
NER-1,6P63T1		63		560x390x800	56		
NER-1,6P100T1		100		680x620x700	79		
NER-1,6P160T1		160		1000x640x700	109		
NER-2,8I20T1		20		420x300x620	48		
NER-2,8I40T1		40		560x390x707	61		
NER-2,8I63T1		63		560x390x847	65		
NER-2,8I100T1		100		680x620x780	75		
NER-2,8P40T1	5,0	40	5,5	560x390x707	60		
NER-2,8P63T1		63		560x390x847	64		
NER-2,8P100T1		100		680x620x780	74		
NER-2,8P160T1		160		1000x620x780	104		
NER-4,5I40T1		6,0		40	7,5	560x390x730	88
NER-4,5I63T1				63		560x390x870	92
NER-4,5I100T1				100		680x620x920	111
NER-4,5I160T1				160		1000x640x880	124
NER-4,5I40T1	40		560x390x690	70			
NER-4,5P63T1	63		560x390x830	74			
NER-4,5P100T1	100		680x620x830	93			
NER-4,5P160T1	160		1000x640x880	123			
NER-6I40T1	6,0	40	7,5	560x390x730	88		
NER-6I63T1		63		560x390x870	92		
NER-6I100T1		100		680x620x920	111		
NER-6I160T1		160		1000x640x920	141		
NER-6P40T1		40		560x390x730	87		
NER-6P63T1		63		560x390x870	91		
NER-6P100T1		100		560x620x920	110		
NER-6P160T1		160		1000x640x920	140		

Model	Output flow rate, l/min	Tank volume, l	Power supply	Electric motor power, kw	Dimensions (BxLxH), mm	Weight*, kg	
NER-10,0I40T1	10,0	40	380V, 50 Hz	11,0	560x390x730	121	
NER-10,0I63T1		63			560x390x870	125	
NER-10,0I100T1		100			680x620x920	145	
H3P-10I160T1		160			1000x640x920	175	
NER-10P40T1		40			560x390x730	121	
NER-10P63T1		63			560x390x870	125	
NER-10P100T1		100			680x620x920	145	
NER-10P160T1		160			1000x640x920	175	
NER-10PKK160T1		160			1000x640x920	183	
NER-10PK3K160T1		160			1000x640x920	187	
NER-10PK4K160T1	160	1000x640x920		190			
NER-18P160T1	18,0	160		22,0	30,0	1000x640x1050	255
NER-18P200T1		200				1000x640x1140	263
NER-18P250T1		250				1000x640x1240	271
NER-18P400T1		400				1510x735x1250	315
NER-18PKK200T1		200				1000x640x1140	271
NER-18PK3K200T1		200				1000x640x1140	274
NER-18PK4K200T1	250	1000x640x1140		277			
NER-25P160T1	25,0	160		30,0	2 x 11,0	1000x640x1085	288
NER-25P200T1		200				1000x640x1275	298
NER-25P250T1		250				1000x640x1275	304
NER-25P400T1		400				1510x735x1275	344
NER-25PK3K250T1		250				1000x640x1275	315
NER-25PK4K250T1		250				1000x640x1275	318
NER-25PKK250P	250	1000x640x1275		312			
2NER-10/10P200T1	10,0x2	200		2 x 22,0	2 x 30,0	1000x640x1010	283
2NER-10/10PKK200T1	200	1000x640x1010				291	
2NER-18/18PKK400T1	18,0x2	400				1510x735x1250	471
2NER-25/25PKK400T1	25,0x2	400				1510x735x1295	511
2NER-18/18P400T1	18,0x2	400				1510x735x1250	465
2NER-25/25P400T1	25,0x2	400	1510x735x1250			502	

Weight of the pump without oil; Feeding oil for pumps is delivered on customer request

With a solenoid valve

Series NEE...G...
Pressure — 700 Bar



Model: NEE-1,6G10F2-Zpk

NEE series pumps are designed for manual remote control.

They are equipped with vibration-proof manometer, safety relief valve, pressure control valve, 2m power supply cable with plug-and-socket connector, remote control panel with 4m cable, powered by safe voltage of 24 V and allowing for engine (start/stop) and solenoid hydraulic directional valve handling.

G series solenoid two-position hydraulic directional valve (GE-2G-1 model) switches between working stroke/idle stroke phases without pressure holding phase (torque-wrenches, cutting tool, grip pullers, pipe benders, pressers, etc.)

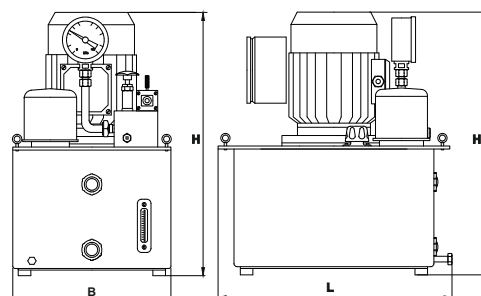

Model	Output flow rate, l/min	Tank volume, l	Power supply	Electric motor power, kw	Dimensions (BxLxH), mm	Weight*, kg	
NEE-0,8G8F1	0,8	8	220V, 50 Hz	1,1	420x250x525	40	
NEE-0,8G10F1		10			420x300x530	41	
NEE-0,8G20F1		20			420x300x610	42	
NEE-0,8G40F1		40			560x290x660	55	
NEE-1,1G8F1	1,1	8		50 Hz	1,5	420x250x525	41
NEE-1,1G10F1		10				420x300x530	42
NEE-1,1G20F1		20				420x300x610	43
NEE-1,1G40F1		40				560x390x660	56
NEE-1,6G10F1	1,6	10		380V, 50 Hz	2,2	420x300x530	42
NEE-1,6G20F1		20				420x300x610	43
NEE-1,6G40F1		40				560x390x660	57
NEE-0,8G8T1		0,8				8	1,1
NEE-0,8G10T1	10		420x300x530	41			
NEE-0,8G20T1	20		420x300x610	42			
NEE-0,8G40T1	40		560x390x660	55			
NEE-0,8G8T1	1,1	8	1,5	420x250x525	40		
NEE-1,1G10T1		10		420x300x530	41		
NEE-1,1G20T1		20		420x300x610	42		
NEE-1,1G40T1		40		560x390x660	56		
NEE-1,6G10T1	1,6	10	2,2	420x300x530	43		
NEE-1,6G20T1		20		420x300x610	44		
NEE-1,6G40T1		40		560x390x660	57		
NEE-2,8G20T1		2,8		20	3,0	420x300x620	52
NEE-2,8G40T1	40		560x390x707	64			
NEE-6,0G40T1	6,0	40	7,5	560x390x730	92		
NEE-6,0G63T1		63		560x390x870	96		
NEE-6,0G100T1		100		620x620x920	115		

* — Weight of the pump without oil; Feeding oil for pumps is delivered on customer request

With a solenoid valve

Series NEE...I...
Pressure — 700 Bar



Model: NEE-5,0I40T1

NEE series pumps are designed for manual remote control. The pump is equipped with vibration-proof manometer, safety relief valve, pressure control valve, 2m power supply cable with plug-and-socket connector, remote control panel with m cable, powered by safe voltage of 24 V and allowing for engine (start/stop) and solenoid hydraulic directional valve handling.

“I” series three-position solenoid hydraulic directional valve (model GE-3IR-1) switches between working stroke/pressure holding/idle stroke phases, allowing for pressure holding (lift cylinders, hydraulic cylinders, pipe benders, etc.)

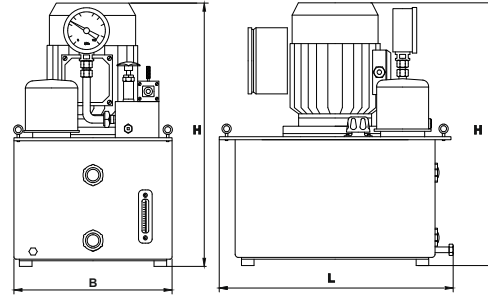

Model	Output flow rate, l/min	Tank volume, l	Power supply	Electric motor power, kw	Dimensions (BxLxH), mm	Weight*, kg				
NEE-0,8I8F1	0,8	8	220V, 50 Hz	1,1	420x250x525	40				
NEE-0,8I10F1		10			420x300x530	41				
NEE-0,8I20F1		20			420x300x610	42				
NEE-0,8I40F1		40			560x390x660	55				
NEE-1,1I8F1	1,1	8		220V, 50 Hz	1,5	420x250x525	41			
NEE-1,1I10F1		10				420x300x530	42			
NEE-1,1I20F1		20				420x300x610	43			
NEE-1,1I40F1		40				560x390x660	56			
NEE-1,6I10F1	1,6	10			220V, 50 Hz	2,2	420x300x530	42		
NEE-1,6I20F1		20					420x300x610	43		
NEE-1,6I40F1		40					560x390x660	57		
NEE-0,8I8T1	0,8	8				220V, 50 Hz	1,1	420x250x525	40	
NEE-0,8I10T1		10						420x300x530	41	
NEE-0,8I20T1		20						420x300x610	42	
NEE-0,8I40T1		40						560x390x660	55	
NEE-1,1I8T1	1,1	8					220V, 50 Hz	1,5	420x250x525	40
NEE-1,1I10T1		10	420x300x530						41	
NEE-1,1I20T1		20	420x300x610						42	
NEE-1,1I40T1		40	560x390x660						56	
NEE-1,6I10T1	1,6	10	220V, 50 Hz					2,2	420x300x530	43
NEE-1,6I20T1		20		420x300x610					44	
NEE-1,6I40T1		40		560x390x660					57	
NEE-2,8I20T1	2,8	20		220V, 50 Hz				3,0	420x300x620	58
NEE-2,8I40T1		40							560x390x707	64
NEE-2,8I100T1		100			680x620x750				89	
NEE-5,0I40T1	5,0	40			380V, 50 Hz			5,5	560x390x730	92
NEE-5,0I63T1		63							560x390x870	96
NEE-5,0I100T1		100				680x620x920			115	
NEE-6,0I40T1	6,0	40				380V, 50 Hz		7,5	560x390x730	92
NEE-6,0I63T1		63							560x390x870	96
NEE-6,0I100T1		100							680x620x920	115
NEE-6,0I160T1		160					1000x640x920		145	
NEE-6,0I40T1	10,0	40					380V, 50 Hz	11,0	560x390x730	124
NEE-6,0I63T1		63							560x390x870	129
NEE-10,0I100T1		100							680x620x920	149
NEE-10,0I160T1		160	1000x640x920						179	
NEE-10AKK160T1	18,0	160	380V, 50 Hz					22,0	1000x640x920	187
NEE-10AK3K160T1		160							1000x640x920	191
NEE-10AK4K160T1		160		1000x640x920					194	
NEE-10K160T1		160		1000x640x920					179	
NEE-18K160T1	25,0	160		380V, 50 Hz				30,0	1000x640x1050	259
NEE-18K200T1		200			1000x640x1140				267	
NEE-18K250T1		250			1000x640x1240				275	
NEE-18K400T1		400			1510x735x1250				319	
NEE-18AKK200T1	2x10,0	200			380V, 50 Hz	2x11,0		1000x640x1140	275	
NEE-18AK3K200T1		200						1000x640x1140	281	
NEE-18AK4K200T1		200						1000x640x1140	287	
NEE-25K160T1		160						1000x640x1085	292	
NEE-25K200T1	2x18,0	200				380V, 50 Hz	2x22,0	1000x640x1175	300	
NEE-25K250T1		250						1000x640x1275	308	
NEE-25K400T1		400						1510x735x1295	348	
NEE-25AKK250T1		250						1000x640x1275	316	
NEE-25AK3K250T1	2x25,0	250	380V, 50 Hz				2x30,0	1000x640x1275	322	
NEE-25AK4K250T1		250						1000x640x1275	326	
2NEE-10/10K200T1		200						1000x640x1010	287	
2NEE-10/10AKK200T1		200						1000x640x1010	295	
2NEE-18/18K400T1	2x18,0	400		380V, 50 Hz			2x22,0	1510x735x1250	469	
2NEE-18/18AKK400T1		400						1510x735x250	475	
2NEE-25/25K400T1	2x25,0	400					380V, 50 Hz	2x30,0	1510x735x1295	510
2NEE-25/25AKK400T1		400							1510x735x1295	514

* — Weight of the pump without oil; Feeding oil for pumps is delivered on customer request

Model	Output flow rate, l/min	Tank volume, l	Power supply	Electric motor power, kw	Dimensions (BxLxH), mm	Weight*, kg
NEE32-2,8ADD20T1	32,0	20	380V, 50 Hz	30,0	450x300x620	47
NEE32-2,8ADD40T1		40			560x530x680	69
NEE32-6ADD40T1		40			570x540x850	85
NEE32-32I160T1		160			1000x660x960	195
NEE32-32I160T1-H		160			1000x660x960	210
2NEE32/14-2,8/32I160T1	2x32,0	160		2x30,0	1000x660x880	280

With an automatic solenoid valve

Series NEA...G...
Pressure — 700 Bar



Model: NEA-1,6G10F2-Zpk

NEA series pumps are fully equipped for both automatic and manual remote control.

Automatic control feature uses either a clock timer to set the desired interval (in seconds) for working and idle strokes, or the boundary values of the pressure in the cavities of hydraulic equipment. Pump is equipped with vibration-proof manometer, safety relief valve, pressure control valve, thermometer and temperature sensor, clock timer, 2m power supply cable with plug-and-socket connector, reserve remote control panel with 4m cable, powered by safe voltage of 24 V and allowing for engine (start/stop) and solenoid distribution valve handling; and an automatic/manual toggle switch.

Solenoid two-position distribution valve "G" series (model "GE-2G-1") switches between working stroke/idle stroke phases without pressure holding phase (torque wrenches, cutting tools, grip pullers, pipe benders, etc.)

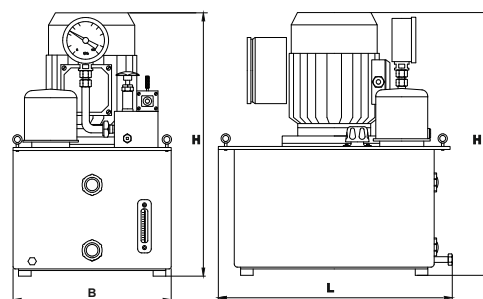

Model	Output flow rate, l/min	Tank volume, l	Power supply	Electric motor power, kw	Dimensions (BxLxH), mm	Weight*, kg
NEA-0,8G8F1	0,8	8	220V, 50 Hz	1,1	420x250x525	40
NEA-0,8G10F1		10			420x300x530	41
NEA-0,8G20F1		20			420x300x610	42
NEA-0,8G40F1		40			560x390x660	55
NEA-1,1G8F1	1,1	8		1,5	420x250x525	41
NEA-1,1G10F1		10			420x300x530	42
NEA-1,1G20F1		20			420x300x610	43
NEA-1,1G40F1		40			560x390x660	56
NEA-1,6G10F1	1,6	10	2,2	420x300x530	42	
NEA-1,6G20F1		20		420x300x610	43	
NEA-1,6G40F1	40	560x390x660	57			
NEA-0,8G8T1	0,8	8	380V, 50 Hz	1,1	420x250x525	40
NEA-0,8G10T1		10			420x300x530	41
NEA-0,8G20T1		20			420x300x610	42
NEA-0,8G40T1		40			560x390x660	55
NEA-1,1G8T1	1,1	8		1,5	420x250x525	40
NEA-1,1G10T1		10			420x300x530	41
NEA-1,1G20T1		20			420x300x610	42
NEA-1,1G40T1		40			560x390x660	56
NEA-1,6G10T1	1,6	10	2,2	420x300x530	43	
NEA-1,6G20T1		20		420x300x610	44	
NEA-1,6G40T1	40	560x390x660	57			
NEA-2,8G20T1	2,8	20	3,0	420x300x620	58	
NEA2,8G40T1		40		560x390x707	64	
NEA6,0G40T1	6,0	40	7,5	560x390x730	92	
NEA6,0G63T1		63		560x390x870	96	
NEA-6,0G100T1		100		680x620x920	115	

* — Weight of the pump without oil; Feeding oil for pumps is delivered on customer request

With an automatic solenoid valve

Series NEA...I...
Pressure — 700 Bar



Model: NEA-1,6I20T1-Zpk

NEA series pumps are fully equipped for both automatic and manual remote control. Automatic control feature uses either a clock timer to set the desired interval (in seconds) for working, pressure holding and idle strokes, or the boundary values of the pressure in the cavities of hydraulic equipment. Pump is equipped with vibration-proof manometer, safety relief valve, pressure control valve, thermometer and temperature sensor, clock timer, 2m power supply cable with plug-and-socket connector, reserve remote control panel with 4m cable, powered by safe voltage of 24 V and allowing for engine (start/stop) and solenoid distribution valve handling; and an automatic/manual toggle switch.

"I" series three-position solenoid distribution valve (model "GE-3IR-1") switches between working stroke/pressure holding/idle stroke phases, allowing for pressure holding (lift cylinders, hydraulic cylinders, pipe benders, etc.)

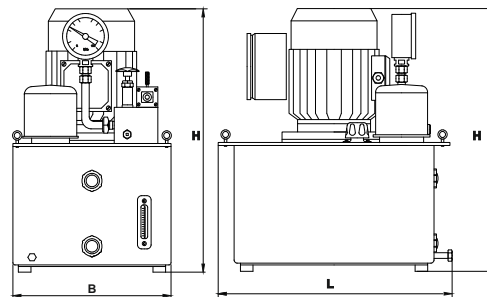

Model	Output flow rate, l/min	Tank volume, l	Power supply	Electric motor power, kw	Dimensions (BxLxH), mm	Weight*, kg		
NEA-0,5I4F1	0,5	4	220V, 50 Hz	1,1	420x250x525	40		
NEA-0,8I8F1		8			420x250x525	40		
NEA-0,8I10F1		10			420x300x530	41		
NEA-0,8I20F1	20	420x300x610			42			
NEA-1,6I40F1	40	560x390x660			55			
NEA-1,6I10F1	1,6	10			2,2	420x300x530	42	
NEA-1,6I20F1		20		420x300x610		43		
NEA-1,6I40F1		40		560x390x660		57		
NEA-0,8I8T1	0,8	8		380V, 50 Hz		1,1	420x250x525	40
NEA-0,8I10T1		10					420x300x530	41
NEA-0,8I20T1		20					420x300x610	42
NEA-0,8I40T1	40	560x390x660			55			
NEA-1,1I8F1	1,1	8	1,5		420x250x525		40	
NEA-1,1I10F1		10			420x300x530		41	
NEA-1,1I20F1		20			420x300x610	42		
NEA-1,1I40F1		40			560x390x660	56		
NEA-1,1I8T1		8			420x250x525	40		
NEA-1,1I10T1		10			420x300x530	41		
NEA-1,1I20T1	1,6	20	2,2		420x300x610	42		
NEA-1,1I40T1		40			560x390x660	56		
NEA-1,6I10T1		10		420x300x530	43			
NEA-1,6I20T1	2,8	20		3,0	420x300x610	44		
NEA-1,6I40T1		40			560x390x660	57		
NEA-2,8I20T1		20			420x300x620	58		
NEA-2,8I40T1	40	560x390x707	64					
NEA-6,0I40T1	6,0	40	7,5		560x390x730	92		
NEA-6,0I63T1		63			560x390x870	96		
NEA-6,0I100T1		100		680x620x920	115			
NEA-10,0I100T1	10	100		11	455x1026x590	133		

* — Weight of the pump without oil; Feeding oil for pumps is delivered on customer request



Model: NEA-0,8G10F1-ZpkK with wheels

Extra options:

N2 — double valve control foot pedal;
Ru — radio remote control with range up to 70 m;
CH — Electric engine frequency regulation;
P — hydraulic fluid heating;
H — hydraulic fluid cooling;
C — digital gauge;
K — tank wheels;
S — folding handles for transportation;
Zk — safety cage;
Dr — flow throttle control.

With electric drive and manual control



**Low price!
High quality!
Light weight!**

Series NER... P...
Pressure — 700 Bar



Model: NER-2P10T1

- Pump drive: electric motor 220/380 V, 50 Hz;
- Hydraulic stations are designed for creation of pressure and liquid supply into hydraulic tools and equipment of ENERPRED;
- Manual control over hydraulic flow using 3-position 4-port flat rotary hydraulic control valve;
- Control valve functions: pulling-out, holdup, return;
- Stations operate with tools and equipment of single and double action;
- Plug-and-socket connection for electric mains;
- IP54 protection and insulation class;
- Safety valve protects from operating pressure excess in hydraulic system;
- Packaged design and light weight for convenient carrying and transportation.

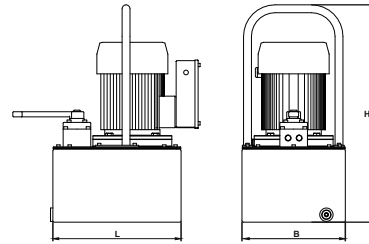

Model	Output flow rate, l/min	Tank volume, l	Power supply	Electric motor power, kw	Dimensions (BxLxH), mm	Weight*, kg
1-stage	1,0	10	220 V, 50 Hz	1,1 kW	475x330x550	37
			380 V, 50 Hz		475x330x550	39
	2,0	10	220 V, 50 Hz	2,2 kW	475x330x550	40
			380 V, 50 Hz		475x330x550	43
	1,0	20	220 V, 50 Hz	1,1 kW	475x330x630	38
			380 V, 50 Hz		475x330x630	40
2,0	20	220 V, 50 Hz	2,2 kW	475x330x630	41	
		380 V, 50 Hz		475x330x630	44	
2-stage	5,0 / 1,6	10	220 V, 50 Hz	2,2 kW	475x330x550	41
			380 V, 50 Hz		475x330x550	44
		20	220 V, 50 Hz		475x330x630	42
			380 V, 50 Hz		475x330x630	45

* — Weight of the pump without oil; Feeding oil for pumps is delivered on customer request

With electric drive and solenoid control



**Low price!
High quality!
Light weight!**

Series NER... P...
Pressure — 700 Bar



Model: NEE-1110T1Pu

- Pump drive: electric motor 220/380 V, 50 Hz;
- Hydraulic stations are designed for creation of pressure and liquid supply into hydraulic tools and equipment of ENERPRED;
- Electromagnetic control over hydraulic flow using 3-position 4-port hydraulic slide control valve;
- Control valve functions: pulling-out, holdup, return;
- Stations operate with tools and equipment of single and double action;
- Plug-and-socket connection for electric mains;
- IP54 protection and insulation class;
- Safety valve protects from operating pressure excess in hydraulic system;
- Packaged design and light weight for convenient carrying and transportation

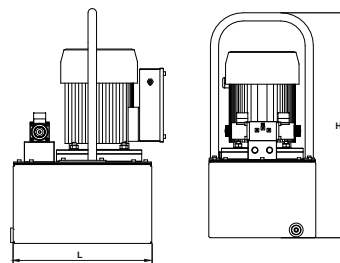

Model	Output flow rate, l/min	Tank volume, l	Power supply	Electric motor power, kw	Dimensions (BxLxH), mm	Weight*, kg
1-stage	1,0	10	220 V, 50 Hz	1,1 kW	475x330x550	38
			380 V, 50 Hz		475x330x550	40
	2,0	10	220 V, 50 Hz	2,2 kW	475x330x550	41
			380 V, 50 Hz		475x330x550	44
	1,0	20	220 V, 50 Hz	1,1 kW	475x330x630	39
			380 V, 50 Hz		475x330x630	41
2,0	20	220 V, 50 Hz	2,2 kW	475x330x630	42	
		380 V, 50 Hz		475x330x630	45	
2-stage	5,0 / 1,6	10	220 V, 50 Hz	2,2 kW	475x330x550	42
			380 V, 50 Hz		475x330x550	45
		20	220 V, 50 Hz		475x330x630	43
			380 V, 50 Hz		475x330x630	46

High-capacity pump stations with multi-hydraulic flow

Series **NER(T)...NEE...(T)**
Pressure — 700 Bar



Model: NER-10AK4K160T1

- Hydraulic stations are designed for creation of pressure and liquid supply into hydraulic tools and equipment of ENERPRED;
- High-capacity pump flow rate up to 25 L/min provide quicker operation of hydraulic tools and equipment due to application of hydraulic distributors of valve type;
- Control of 2-8 tools simultaneously (manual mode or remote control panel)
- Manual and electromagnetic control over hydraulic flow;
- Stations operate with tools and equipment of single and double action;
- Electric main characteristics: 380 V, 50 Hz;
- Plug-and-socket connection for electric mains;
- IP54 protection and insulation class;
- Safety valve protects from operating pressure excess in hydraulic system.

	Model	Output flow rate, l/min	Tank volume, l	Number of tools	Electric motor power, kW	Dimensions (BxLxH), mm	Weight, kg
Manual control	NER-10AKK160T1	10,0	160	1	11,0	1000x640x920	183
	NER-10AK3K160T1			3		1000x640x920	187
	NER-10AK4K160T1			4		1000x640x920	190
	NER-18AKK200T1			1		1000x640x1140	271
	NER-18AK3K200T1	18,0	200	3	22,0	1000x640x1140	274
	NER-18AK4K200T1			4		1000x640x1140	277
	NER-25AKK250T1			1		1000x640x1275	312
	NER-25AK3K250T1	25,0	250	3	30,0	1000x640x1275	315
	NER-25AK4K250T1			4		1000x640x1275	318
NEE-10AKK160T1	1			1000x640x920		187	
Electromagnetic control	NEE-10AK3K160T1	10,0	160	3	11,0	1000x640x920	191
	NEE-10AK4K160T1			4		1000x640x920	194
	NEE-18AKK200T1			1		1000x640x1140	275
	NEE-18AK3K200T1			18,0		200	3
	NEE-18AK4K200T1	4	1000x640x1140		287		
	NEE-25AKK250T1	1	1000x640x1275		316		
	NEE-25AK3K250T1	25,0	250	3	30,0	1000x640x1275	322
	NEE-25AK4K250T1			4		1000x640x1275	326

With explosion-proof electric motor and manual valve

Series **VNER...I...**
Pressure — 700 Bar



Model: VNER-1,6I40T1

VNER series pumps are similar to NER pumps, although being equipped with explosion-proof engine. They are supplied without electrical connection equipment. The engine must be connected to the explosion-proof engine starter on the working site in accordance with safety rules and regulations of the electrical code.

Basic models are equipped with vibration-proof gauge, safety valve, pressure regulator. The hydraulic equipment is controlled by the "I" series three-position manual distribution valve (model "GR-3IR-1") allowing for working stroke/pressure holding/idle stroke phases (lift cylinders, hydraulic cylinders, pipe benders, etc.) Could be used with any type of hydraulic equipment and tools, both single-acting and double-acting. Additional equipment could be installed, like a thermometer, wheels for transportation, folding handles for carrying by 2 to 4 staff members (available for stations with tanks of 40, 63, and 100 liters).

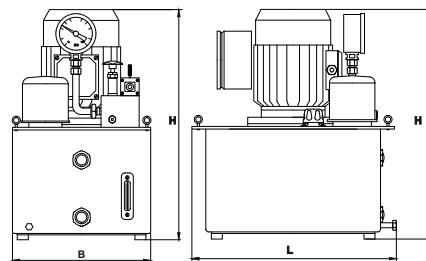

Model	Output flow rate, l/min	Tank volume, l	Power supply	Electric motor power, kw	Dimensions (BxLxH), mm	Weight*, kg	
VNER-1,6I10T1	1,6	10	380V, 50 Hz	2,2	420x300x530	56	
VNER-1,6I20T1		20			420x300x610	58	
VNER-1,6I40T1		40			560x390x660	64	
VNER-1,6I63T1	63	560x390x800			65		
VNER-2,8I20T1	2,8	20			3,0	420x300x620	75
VNER-2,8I40T1		40				560x390x707	81
VNER-2,8I63T1		63		560x390x847		84	
VNER-5,0I40T1	5,0	40		7,5	560x390x730	143	
VNER-5,0I63T1		63			560x390x870	145	
VNER-5,0I100T1		100			680x620x920	150	
VNER-10,0I100T1	10	100		11	680x620x920	160	

* Weight of the pump without oil; Feeding oil for pumps is delivered on customer request

Since the station series VNER are supplied without remote and automatic control electrical equipment, it is highly recommended to connect a hydraulic tool with built-in valve to VNER pump.

Additional options for explosion-proof stations



CERTIFICATE



Explosion proof mark of the pumping station: **Ex II Gb IIB T4 X**.
 The pumping stations are produced according to: **TS 4145-005-18940057-2014**
 In 2014 company **ENERPRED** obtained the certificate for production of pumping stations in explosion-proof modification.



1- Ekv Control cabinets

Control cabinets and explosion-proof alarms of ShUS type are designed to control, distribute, and commute electrical energy in the circuits of different purposes, alarm about parameters and operation modes of these circuits and their protection in explosion-hazardous areas of enterprises of coal, chemical, oil-refining, gas, and other sectors of industry where, under the operation conditions, there is a possibility of generation of explosion-hazardous mixtures of gases and vapors with air of I, IIA, IIB, IIC categories and T1-T5 groups.

2- Puv Control stations

The stations are designed for remote control over electric motor starting and control over electrical hydraulic distributor magnets. The stations are designed for operation: with 2ExdIICT6 explosion proof mark – in explosion-hazardous areas of productions, transport means, and storage of products of chemical, oil-refining, gas and other sectors of industry.

2- Shv Cable plug/socket

Explosion-proof connectors are designed for quick connection and disconnection of cabling sections, hydraulic stations with power sources in the ground stationary and mobile electric installations with voltage up to 440 V DC and AC frequency up to 60 Hz.

Designation of the pumping stations in explosion-proof modification

Kh⁰ VNE Kh¹ Kh²-Kh³ Kh⁴ Kh⁵ Kh⁶ Kh⁷-Kh⁸-Kh⁹, where:

Kh⁰ – quantity of pressure outlets (1- single flow, accepted by default and not filled-in; 2, 3, 4 – pressure outlets with independent pressure and flow rate);

V – type of execution, -explosion-proof;

N – pumping station;

E – with electric motor;

Kh¹ – type of control over hydraulic control valve;

R – manual;

E – solenoid control;

A – solenoid control in automatic mode;

Kh² – rated operating pressure, Bar.

Selected from the row according to GOST 12445-80: 0.2; 0.32; 0.4; 0.5; 0.63; 0.8; 1.0; 1.6; 2.0; 2.5; 2.8; 3.2; 4.0; 5.0; 6.3; 8.0; 10.0; .. 90.0 L/min.

Kh³ – capacity, L/min.

Kh⁴ – type of hydraulic control valve:

G – 2-position control valve (type G); **D** – 3-position control valve (type D); **I** – 3-position control valve (type I); **D2-D8** – from 2 to 8 3-position control valves (type D); **K** – with valve; **P** – slide-type.

Kh⁵ – volume of hydraulic tank, L.

Selected from the row: 4, 8, 10, 20, 40, 63, 100, 160, 200, 250, 400.

Kh⁶ – type of supply line: **F** – single-phase network, AC, frequency 50, 60 Hz, 220 V; **T** – three-phase network, AC, frequency 50, 60 Hz, 380 (660) V.

Kh⁷ – quantity of pumping stages:

1 – one-stage hydraulic stations;
 2 – two-stage hydraulic stations;
 3 – three-stage hydraulic stations;
 4 – four-stage hydraulic stations.

Kh⁸ – pumping station modification with remote control cabinet:

Mb – monoblock unit;

Rsh – station and electric control cabinet are spread apart;

Bsh – without control cabinet;

Kh⁹ – additional options.

With a manual relief valve

Series NBR...A...
Pressure — 700 Bar



Model: NBR-1,6I40-1

NBR series pumps are designed for operation in the absence of a power supply. Rotation of the pump is performed by a four-stroke, air-cooled gasoline engine. The hydraulic equipment is controlled by manual relief valve or manual three-position distribution valve mounted on the pump.

NBR...A... series pumps are supplied without a pressure gauge and pressure valve.

These parts are optional and, if necessary, must be ordered separately. "A" series manual relief valve (model "RK-80/5-1") operates in a two-stroke mode (working/idle) without pressure holding phase (cutting tools, grip pullers, pipe benders, etc.)

NBR...I... series pumps are equipped with a vibration proof gauge, safety valve and pressure regulator valve. "I" series manual three-position valve (model "GR-3IR-1") operates in a three-position mode (working/pressure/idle), allowing for the pump to be used with any type of hydraulic equipment and tools, both single-acting and double-acting (lift cylinders, hydraulic cylinders, pipe benders, etc.).

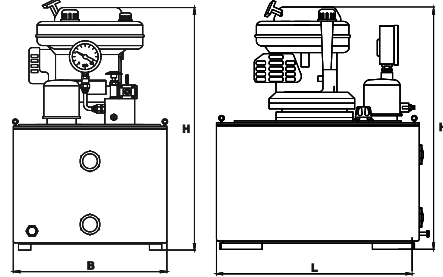

Model	Output flow rate, l/min	Tank volume, l	Petrol	Petrol motor power, kW (h. p.)	Dimensions (BxLxH), mm	Weight*, kg
NBR-0,4A4-1	0,4	4	AI92; AI95; AI98	1,6 (2,1)	360x270x465	18
NBR-0,8A4-1-Zk	0,8	4			610x390x410	30
NBR-1,2A4-1-Zk	1,2	4			610x380x410	33
NBR-1,2A8-1		8			470x360x534	35
NBR-1,6A8-1	1,6	8		470x360x534	37	
NBR-1,6A10-1		10		330x570x430	33	
NBR-1,6A20-1		20		370x620x430	34	
NBR-1,6A40-1		40		530x720x560	41	
NBR-1,6A63-1		63		63	530x720x560	41
					580x1940x828	54

* — Weight of the pump without oil; Feeding oil for pumps is delivered on customer request

With a manual distribution valve

Series NBR...I...
Pressure — 700 Bar



Model: NBR-1,0I4-1



Model: NBR-1,6I20-1 MRZk



Model: NBR-10I160-1 Zpk
in the semi-frame

Extra options:

- T — thermometer;
- Dr — flow throttle control;
- K — tank wheels;
- S — folding handles for transportation;
- Zk — safety cage;
- Zpk — protective semi-frame

Special options for NBR...A...

- R — pressure safety valve (PSV);
- M — gauge;

B2 (B3, B4) — spacer rings for parallel connection of 2 to 4 hydraulic tools for simultaneous operation.

Model	Output flow rate, l/min	Tank volume, l	Petrol	Petrol motor power, kW (h. p.)	Dimensions (BxLxH), mm	Weight*, kg
NBR-0,4I4-1	0,4	4	AI92; AI95; AI98	1,6 (2,1)	360x270x465	19
NBR-0,8I4-1-Zk	0,8	4			610x390x410	30
NBR-1,2I4-1-Zk	1,2	4			610x380x410	33
NBR-1,2I8-1		8			470x360x534	35
NBR-1,6I8-1	1,6	8		470x360x534	37	
NBR-1,6I10-1		10		470x360x534	38	
NBR-1,6I20-1		20		470x360x614	40	
NBR-1,6I40-1		40		580x390x688	50	
NBR-1,6P10-1		10		10	470x360x534	37
NBR-1,6P20-1					20	470x360x614
NBR-1,6P40-1	40	40		580x390x688	49	
NBR-1,6P63-1				63	580x390x768	55
NBR-1,6P100-1	100	100		680x620x818	75	
NBR-2,4I20-1	2,4	20		490x380x630	45	
NBR-2,4I40-1		40		580x390x705	55	
NBR-2,4I63-1		40		580x380x785	61	
NBR-2,4P10-1		10		580x380x550	42	
NBR-2,4P20-1		20		580x380x630	44	
NBR-2,4P40-1		40		580x390x705	54	
NBR-2,4P63-1		63		580x390x785	60	
NBR-2,4P100-1		100		100	680x620x835	80

Model	Output flow rate, l/min	Tank volume, l	Petrol	Petrol motor power, kW (h. p.)	Dimensions (BxLxH), mm	Weight*, kg
NBR-5,0I40-1	5,0	40	Ai92; Ai95; Ai98	7,8(9,5)	610x390x585	86
NBR-5,0I63-1		63			610x390x665	90
NBR-5,0I100-1		100			690x620x715	110
NBR-5,0I160-1		160			1000x640x715	140
NBR-5,0P40-1		40			610x390x585	85
NBR-5,0P63-1		63			610x390x665	89
NBR-5,0P100-1	10,0	100		17,6(24)	690x620x715	109
NBR-5,0P160-1		160			1000x640x835	110
NBR-10,0I100-1		100			1740x720x890	212
NBR-10,0I160-1		160			1740x720x990	220

* — Dry weight of the pumping station is specified. Oil for refilling is supplied on customer's demand

With solenoid control valve

NBR... P(K)...

Pressure – 700 Bar



Model: NBR-10P100-1 with electric start of petrol motor



Model: NBR22/70-32/9P160-2-Ku4B4 with electric start of petrol motor

Model	Output flow rate, l/min	Tank volume, l	Petrol	Petrol motor power, kW (h. p.)	Dimensions (BxLxH), mm	Weight*, kg
NBR-10,0P100-1	10,0	100	Ai92; Ai95; Ai98	17,6 (24)	1740x720x890	212
NBR-10,0PKK100-1		100			1740x720x890	219
NBR-10,0PK3K100-1		100			1740x720x890	222
НБР-10,0PK4K100-1		100			1740x720x890	225
NBR-10,0P160-1		160			1740x720x890	220
NBR-10,0PKK160-1		160			1740x720x890	227
NBR-10,0PK3K160-1		160			1740x720x890	230
NBR-10,0PK4K160-1		160			1740x720x890	233

With solenoid control valve

NBE... K...

Pressure – 700 Bar



Model: NBE-10K160-1 with electric start

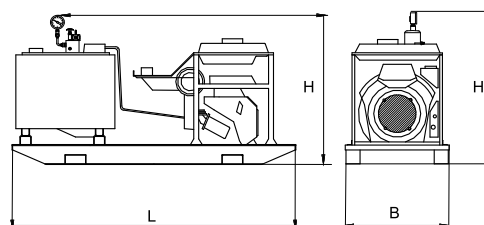

Additional options:

- B...4 — block for connection from 2 to 4 hydraulic tools;
- Bt25 — fuel tank 25 liters;
- BU1...4 — control unit for 1-4 hydraulic tools;
- Dr — throttle regulator;
- Zk — safety cage;
- Zpk — safety semi-cage;
- lr — flow meter;
- K — wheels;
- Ku02...04 — control valve for 2-4 hydraulic tools;
- Ku3 — three control valves for 3 hydraulic tools;
- Me — electric-contact pressure gage;
- R — pressure regulator;
- Sm — hourmeter;
- T — thermometer;

Special options for NBE...P...

- Pu — control panel (special);
- Pru — radio control box;
- Ts — digital pressure gage;
- Ek — electrical box (special).

Model	Output flow rate, l/min	Output flow rate, l/min	Petrol	Petrol motor power, kW (h. p.)	Dimensions (BxLxH), mm	Weight*, kg
NBE-10,0K100-1	10,0	100	Ai92; Ai95; Ai98	17,6 (24)	1740x720x890	216
NBE-10,0KK100-1		100			1740x720x890	225
NBE-10,0K3K100-1		100			1740x720x890	228
NBE-10,0K4K100-1		100			1740x720x890	231
NBE-10,0K160-1		160			1740x720x890	224
NBE-10,0KK160-1		160			1740x720x890	233
NBE-10,0K3K160-1		160			1740x720x890	237
NBE-10,0K4K160-1		160			1740x720x890	241

With manual control valve

Series NDR... I(P, K)...
Pressure – 700 Bar



Model: NDR-5,0I63-1-3k



Control panel PU70-4 with four manual 3-position hydraulic control valves and one discharging control valve for pump stations NDR (NBR, NER)....A...



Model: NDR-10A100-1

Series NDR... P... – are equipped with manual flat rotary control valve and control units for two (KK) – four (K4K) manual control valves (operating in multiple) or with control panels PU50...70-2...6

Model	Output flow rate, l/min	Tank volume, l	Petrol	Petrol motor power, kW (h. p.)	Dimensions (BxLxH), mm	Weight*, kg
NDR-5,0I40-1	5,0	40	Diesel fuel	5,4 (7,3)	700x542x830	94
NDR-5,0I63-1		63			700x542x970	99
NDR-5,0I100-1		100			700x542x1320	108
NDR-5,0P100-1		100			700x542x1320	110
NDR-10,0P100-1	10,0	100		17,6 (24)	1740x720x1150	242
NDR-10,0PK100-1		100			1740x720x1150	249
NDR-10,0PK3K100-1		100			1740x720x1150	252
NDR-10,0PK4K100-1		100			1740x720x1150	255
NDR-10,0P160-1		160			1740x720x1150	250
NDR-10,0PK160-1		160			1740x720x1150	257
NDR-10,0PK3K160-1		160			1740x720x1150	260
NDR-10,0PK4K160-1		160			1740x720x1150	263

With solenoid control valve

Series NDE... K...
Pressure – 700 Bar



Model: NDE-10K100-1-Pu10 with panel 10m

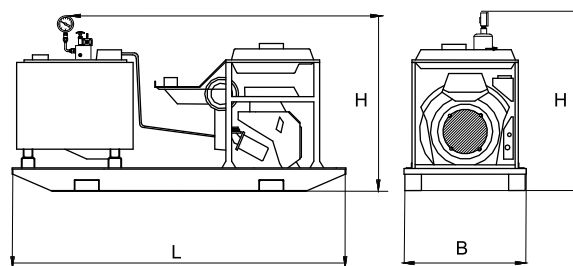

Series NDR...K... – are equipped with one (K) – four (K4K) solenoid control valves (operating in multiple).

Special options for NDE...K...

- Pu — control panel (special);
- Pru — radio control box;
- TS — digital pressure gage;
- Ek — electrical box (special).

Model	Output flow rate, l/min	Tank volume, l	Petrol	Petrol motor power, kW (h. p.)	Dimensions (BxLxH), mm	Weight*, kg
NDE-10,0K100-1	10,0	100	Diesel fuel	17,6 (24)	1740x720x1150	246
NDE-10,0KK100-1		100			1740x720x1150	255
NDE-10,0K3K100-1		100			1740x720x1150	258
NDE-10,0K4K100-1		100			1740x720x1150	261
NDE-10,0K160-1		160			1740x720x1150	254
NDE-10,0KK160-1		160			1740x720x1150	263
NDE-10,0K3K160-1		160			1740x720x1150	267
NDE-10,0K4K160-1		160			1740x720x1150	271

With a manual relief valve

Series NPR...A... Pressure — 700 Bar



Model: NPR-1,6A10-1-FM-M with moist separator filter, oil lubricator (FM) and gauge

NPR pumps are equipped by a plate-type pneumatic engine operating as a pump actuator. It could be powered by any air supply line with pressure up to 6,2 Bar**, feed of 4.3 m³ / min and nominal diameter (DN) of the pipe at least 16 mm. The hydraulic equipment is controlled by manual relief valve or manual three-position distribution valve and air valve (feed control) installed at the pump. It is recommended to equip the “NPR” pump with an air handling unit (filter / lubricator), if used air supply line does not include this equipment. The presence of air handling unit in the set is designated by letters F (air filter / drip leg) and M (oil lubricator), such as NPR-1,6I10-1AM (with filter and oil distributor), NPR-1,6I40-1-F (with filter/drip leg only). NPR...A... series pums are supplied without gauge and pressure control valve. These parts are optional and, if necessary, must be ordered separately. “A” series manual relief valve (model “RK-80/5-1”) operates in a two-stroke mode (working/idle) without pressure holding phase (cutting tools, grip pullers, pipe benders, etc.)

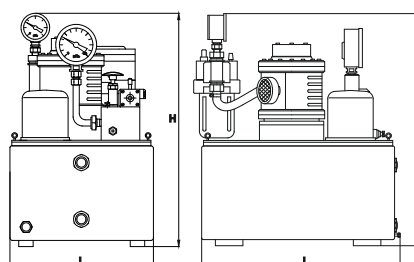

Pumps NPR...A... series without air preparation units

Model	Output flow rate, l/min	Tank volume, l	Air pressure, Bar, min	Pneumatic motor power, kW	Dimensions (BxLxH), mm	Weight*, kg
NPR-1,6A10-1	0,8-2,5	10	4-62	4,0	420x300x480	35
NPR-1,6A20-1		20			420x300x560	37
NPR-1,6A40-1		40			520x390x610	49

With a manual distribution valve

Series NPR...I... Pressure — 700 Bar

“I” series three-position manual control valve (model GR-3IR-1) switches between working stroke/pressure holding/idle stroke phases, allowing for pressure holding (lift cylinders, hydraulic cylinders, pipe benders, pressers, etc.)

NPR...I... series pumps without air preparation units

Model	Output flow rate, l/min	Tank volume, l	Air pressure, Bar, min	Pneumatic motor power, kW	Dimensions (BxLxH), mm	Weight*, kg
NPR-1,6I10-1	0,8-2,5	10	4-62	4,0	420x300x480	36
NPR-1,6I20-1		20			420x300x560	38
NPR-1,6I40-1		40			520x390x610	50

* Weight of the pump without oil; Feeding oil for pumps is delivered on customer request

** If pressure in the air supply exceeds 6,2 Bar, the pump must be equipped with an air pressure regulator.



Model: NPR-1,6I10-1-FM-Zpk with air filter and air-oil lubricator



Model: air filter and air handling unit FM

Extra options:

FM — air filter (F) with a drip leg and an air-oil lubricator (M);
T — thermometer;
Dr — flow throttle control;
K — tank wheels;
S — folding handles;
Zk — safety cage;

Extra options for HPP...A...

R — control safety valve (PSV);
M — gauge;
B2 (B3, B4) — spacer rings for parallel connection of 2 to 4 hydraulic tools for simultaneous operation.

Electric pump

Series **NER...A(I)...**
Pressure — 700 Bar



Model: NER-0,5A4T1



Model: NEA-0,5G4T1-RMSH

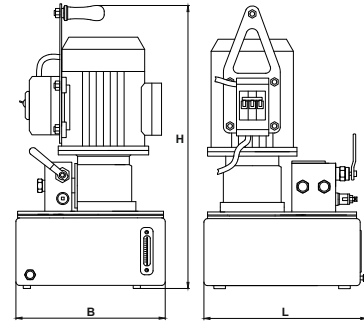

Portable pumps are simplified versions of standard pumps described above, being light-weighted and using a smaller 4 liter tank. Basic versions of portable pumps contain only the minimum equipment required for operation and supplied without pressure control valve, thermometer, gauge, power cable with plug-and-socket connector. If the operating conditions of the pump demand inclusion of these elements, they must be ordered as separate options. Hydraulic control is provided by means of "A" series manual relief valve (model RK.80/5-1) and "I" series three-position manual distribution valve (model GR-3IR-1).

Model	Output flow rate, l/min	Tank volume, l	Power supply	Pneumatic motor power, kW	Dimensions (BxLxH), mm	Weight*, kg
NER-0,5I4F1	0,5	4	220V, 50 Hz	0,55	220x230x495	18
NER-0,5A4F1					220x230x495	17
NER-0,5I4T1			380V, 50Hz		220x230x495	18
NER-0,5A4T1					220x230x495	17

* — Weight of the pump without oil; Feeding oil for pumps is delivered on customer request

Series **NEA...G(I)...** and **NEE...G(I)...**
Pressure — 700 Bar

Hydraulic control is provided by means of "I" series (model GE-3IR-1) and "G" series (model GE-2R-1) solenoid distribution valves.

Model	Output flow rate, l/min	Tank volume, l	Power supply	Pneumatic motor power, kW	Dimensions (BxLxH), mm	Weight*, kg
NEE-0,5G4G1	0,5	4	220V, 50 Hz	0,55	305x230x495	23
NEE-0,5I4F1					360x230x495	24
NEE-0,5G4T1			380V, 50Hz		305x230x495	23
NEE-0,5I4T1					360x230x495	24
Model	Output flow rate, l/min	Tank volume, l	Power supply	Pneumatic motor power, kW	Dimensions (BxLxH), mm	Weight*, kg
NEA-0,5G4F1	0,5	4	220V, 50 Hz	0,55	305x230x495	23
NEA-0,5I4F1					360x230x495	24
NEA-0,5G4T1			380V, 50Hz		305x230x495	23
NEA-0,5I4T1					360x230x495	24

* — Weight of the pump without oil; Feeding oil for pumps is delivered on customer request

Extra options:

- T— thermometer;
- M— gauge;
- SH—plug-and-socket connector;
- R—pressure safety value (PSV);
- Zk—safety cage;
- H— hydraulic fluid cooling;
- C—digital gauge;
- Ru—radio remote control with range up to 70 m.

Extra options for NER...A...

- B2 (B3, B4) — collector spacer rings for parallel connection of 2 to 4 hydraulic tools for simultaneous operation.

Portable gasoline

Series NBR...A...*, NBR...I...*



Model: NBR-0,514-1-RMT

Extra options for NPR:

T — thermometer;
M — gauge;
R — pressure control gauge;
Zk — safety cage.

Special options for NPR...A...

B2 (B3, B4) — collector spacer rings for parallel connection of 2 to 4 hydraulic tools for simultaneous operation.

Model	Output flow rate, l/min	Tank volume, l	Petrol	Petrol motor power, kW (h. p.)	Dimensions (BxLxH), mm	Weight*, kg
NBR-0,5A4-1	0,5	4	AI92; AI95; AI98	1,6 (2,1)	360x270x465	18
NBR-0,514-1					360x270x465	19

Air pump

Series NPR...A..., NPR...I...

Model	Output flow rate, l/min	Tank volume, l	Air pressure, Bar, min	Pneumatic motor power, kW	Dimensions (BxLxH), mm	Weight*, kg
NPR-0,5A4-1	0,3-0,7	4	6,3	0,55-1,1	220x230x495	14
NPR-0,514-1					220x230x495	15

* — Weight of the pump without oil; Feeding oil for pumps is delivered on customer request



Model "NPR-0,514-1-RMT" with pressure regulator, pressure gauge and thermometer



Model "NPR-0,5A4-1-RMT" with pressure regulator, gauge and thermometer



Model: GKG 500 torque wrench

Model: NEA-0,5G4T1-RMSHT with pressure control valve and gauge, plug-and-socket connector and thermometer

Extra options:

T — thermometer;
M — gauge;
R — pressure safety value (PSV);
Zk — safety cage.



Model: NEE-0,514T1-RM with pressure control valve and gauge

Additional options for pumps



T — thermometer

Recommended for installation in pumps tanks working under heavy load for a long time. On special demand, a digital thermometer could be installed.



Ru — radio remote control

Radio remote control, having up to 5 channels, can be used for starting/stopping the engine, handling of the solenoid valve, secondary control circuits, etc. Operation range is 70 m.

P — hydraulic fluid heating

Designed for pump operation at low temperatures (down to -40 degrees), includes a heating element and an electrical circuit. Switching on and off is carried out manually or automatically, if the temperature sensor is installed.



Zk — safety cage

Safety cage is designed for pumps with tank volume of 4, 10, 20, 40 and 63 liters. The cage guards the pump from physical damage on site and during transportation, and allows mounting or connecting additional units of hydraulic equipment, folding handles, etc.



H — heat exchanger

Consists of a radiator and a fan for cooling of hydraulic fluid drained into the tank. Recommended for installation in pumps for long-term operation with a processing equipment, and especially pumps where the volume of the tank is less than required for a three-minute operation.



K — tank wheels

Designed for moving the pump between workshops and other facilities. In order to prevent the spontaneous moving, wheels are equipped with brakes.



N — control foot pedal

Designed for control of pump electric equipment like valves and the engine. It is recommended for pumps working with presses, cutters, pipe benders, and similar processing equipment.



B2 (B3 or B4) — collector spacer rings

A special collector with spacer rings for connection of intake and output of 2 to 4 units of single-action hydraulic equipment (with spring or gravity return) to a single pump, providing simultaneous flow of hydraulic fluid to all units.



PU — manual control panel

PU50...70-2...6 is designed for connection to pump stations with pressure of 500...700 Bar and contains from two to six manual 3-position hydraulic control valves and one discharging control valve (shortened handle).



Dr — flow throttle control

Throttle control provides a variable fluid consumption from the pump to the pressure (return) line using installed throttling element or flow controller.



CH — frequency regulation

Frequency regulation of rotating speed of the pump engine provides a variable flow of hydraulic fluid in the range of 1:5.



C — digital gauge

It can be installed in the pump instead of common gauge. Has a higher accuracy class, data display configuration interface, hydraulic equipment pressure control interface and PC output interface. The maximum scale values are 100 and 255 Mpa. 24V, DC.

Additional options for pumps

Equipment of the pumps with several valves



Model — BU4

- ADD — two valves with normally closed neutral and relief valve for connection of two independent double-action hydraulic cylinders (pressure up to 800 Bar)
- AD3D, AD...D — for handling of three and more double-action hydraulic cylinders (pressure up to 800 Bar)
- BU2 — two valves with relieved neutral for connection of two independent double-action hydraulic cylinders (pressure up to 305 Bar)
- BU3, BU... — for handling of three and more double-action hydraulic cylinders (pressure up to 350 Bar)

Pump control electric boxes

For series NER

Allows to control the start / stop operations of the pump engine using the buttons on the electric box case. Incorporates a magnetic starter and an engine protection thermal relay.
Power supply: 220 V, 380 V
Operating voltage: 220 V

For series NEE

Allows to control the start / stop operations of the pump engine via cable using the remote control panel. Incorporates a magnetic starter and an engine protection thermal relay.
Power supply: 220 V, 380 V
Operating voltage: 24 V

For series NEA

Allows to control the start / stop operations of the pump engine via cable using the remote control panel. Incorporates a magnetic starter and an engine protection thermal relay.
Power supply: 220 V, 380 V
Operating voltage: 24 V

Radio remote control panel

Allows to control manage all types of pumps beside the standard cable remote control panel, doubling all of its functions. For NER pumps an engine control is implemented.
Operation range: 70 m
Operating voltage: 12 V

Operating system for continuous maintaining of a constant pressure in the hydraulic system.

- Designed to automatically maintain a constant pressure in the hydraulic pump (within the defined limit values).
- Makes the constant operation of the pump redundant, effectively reducing the pump load.
- Dramatically reduces the heating fluid process, increases the life time of the pump.

This is implemented with a digital gauge (CM) connected to the control electric box of the pump. This system allows reducing the load on the pump in cases when it is required to maintain a constant load. Gauge provides for the pumping operation to become intermittent, turning feed on when the pressure decreases to the lower boundary of the defined range and turning feed off when the pressure reaches the top. Digital gauge can be connected to a personal computer via COM port:

- Laboratory and testing equipment;
- Pile pressing machines;
- Retention devices, such as clips, etc.

Locking-valve elements of hydraulic systems

Locking-valve elements are designed to provide control of hydraulic fluid flow (and hence the operation of hydraulic equipment or tools) and regulate the pressure in the hydraulic system.

Multi-stage valves



Model: KMH4



Model: KRAN003/40



Model: KRAN003

Multi-stage valves are designed to provide simultaneous operation of multiple hydraulic equipment (such as one-way lift cylinders) by means of connection to a single pressure source.

Each position of the valve has a separate flow control. The number of separate valves in the multiway valve can be increased on customer's request.

Model	Number of stages	Threads
KMH	1	K3/8"
KMH2	2	K3/8"
KMH3	3	K3/8"
KMH4	4	K3/8"
KMH5	5	K3/8"
KMH6	6	K3/8"
KRAN-002/40	2	K3/8"
KRAN-003/40	3	K3/8"
KRAN-004/40	4	K3/8"
KRAN-002	2	K3/8"

Model	Number of stages	Threads
KRAN-003	3	K3/8"
KRAN-004	4	K3/8"
KRAN-005	5	K3/8"
KRAN-006	6	K3/8"
KRAN-007	7	K3/8"
KRAN-008	8	K3/8"
KRAN-009	9	K3/8"
KRAN-012	12	K3/8"
KRAN-016	16	K3/8"
D2P		2-section valve
D4P		4-section valve

External valves



Model: GE-2DR-2

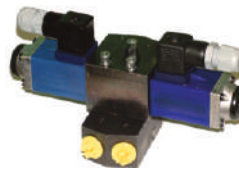

Model: GE-3DR-2



Model: GR-3IR-2

External valves are designed for installation and control of hydraulic equipment or tools in any convenient location away from the hydraulic pump (like right next to the lift cylinder of nut-runner).

External valve is essentially a distributing device for handling the flow of hydraulic fluid, mounted on remote collector plate, connected to hoses from the pressure source (pump).

Model	Type scheme	Name	Connecting threads	Hydraulic circuit
GR-3DR-2	D	Distributor spool hydraulic 3-position 4-linear, with manual control and locked neutral	K3/8"	
GR-3IR-2	I	Spool valve hydraulic 3-position 4-linear, with manual control and unloaded neutral		
GE-2GR-2	G	Distributor spool hydraulic 2-position 4-linear, with electromagnetic control and unloaded neutral		
GE-3DR-2	D	Spool valve hydraulic 3-position 4-linear, electromagnetically controlled and locked neutral		
GE-3IR-2	I	Spool distributor, hydraulic 3-position 4-linear, electromagnetically controlled and unloaded neutral		
GR43P-2	P	Distributor of flat-pivot hydraulic 3-position 4-linear, with manual control and unloaded neutral, cavities A and B are locked		
GR44P-2	D	Distributor of flat-pivot hydraulic 3-position 4-linear, with manual control and unloaded neutral		
GR-3K-2	K	Distributor valve hydraulic 3-position 4-linear, with manual control and a locked neutral		

External safety valve

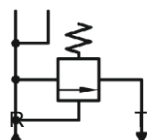

PK-80/5-2

External safety valve is meant for throttling the hydraulic fluid by partial discharging to the outlet drain in case of exceeding the set pressure value, effectively adjusting the flow rate and pressure in the pipeline. Can be installed anywhere in the hydraulic system and sealed. External valve is essentially a valve with an adjustment knob screwed into a hydraulic round collector with threads for mounting of pressure and return hoses.

Model	Max. operating pressure, Bar	Thread
PK-80/5-2	800	K3/8"

External relief valve

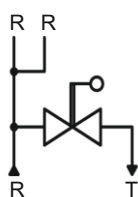

RK-80/5-2

External relief valve is meant for throttling the hydraulic fluid by partial discharging into the tank, effectively adjusting the flow rate and pressure in the pipeline. Can be installed anywhere in the hydraulic system. External relief valve is essentially a valve with an adjustment knob screwed into a hydraulic round collector with threads for mounting of pressure and return hoses.

Model	Max. operating pressure, Bar	Thread
RK-80/5-2	800	K3/8"

Side-mounted control safety valve

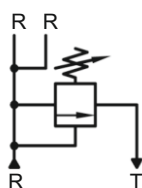

RPK-80/5-2

External control safety valve is meant for throttling the hydraulic fluid by partial discharging to the outlet drain in case of exceeding the set pressure value, effectively adjusting the flow rate and pressure in the pipeline. Can be installed anywhere in the hydraulic system. External relief valve is essentially a valve with an adjustment knob screwed into a hydraulic round collector with threads for mounting of pressure and return hoses.

Model	Max. operating pressure, Bar	Thread
RPK-80/5-2	800	K3/8"

Indicators and gauges



Digital gauge M100C up to 1000 Bar



T-127 Oil level gauge with thermometer, 127 mm and 76 mm. in length.



T-76



GU-1



Models: M100VD100 and M100VD63

Indicators and gauges are meant to inform the user about the state of the pump, its pressure, level and temperature of the hydraulic fluid in the tank.

Gauges are designed to control and monitor the pressure in the hydraulic system and can be installed through the use of adapter anywhere on the line or actuator. Gauges are filled with silicone oil or glycerine, their construction is vibration proof. Operating temperature ranges from -30°C to +80°C. Gauges can be either vertical (radial) or axial type. Maximum scale ranges up to 1000 Bar.

Model	Scale range, Bar	Diameter, mm	Accuracy class	Thread
M100VD63	0-1000	63	1,6	G1/4"
M100VD100	0-1000	100	1,0	G1/2"
M1D40 (axiel)	0-10	40	2,5	M10x1

Gauge adapters



Model: MA-3-G1/4"



Model: MA100VU63 (gauge M100VD63 in the MA-3-G1/4" adapter)

These adapters are designed for installation of gauges in any convenient place of the hydraulic system lines.

Model	Length, mm	Thread	Weight, kg
MA-2-G1/2"	120	K3/8"-G1/2"-K3/8"	0,6
MA-3-G1/4"	150	K3/8"-G1/4"-K3/8"	0,75

High pressure hoses

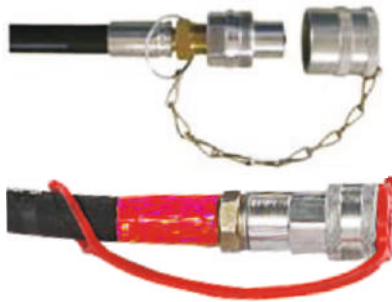

Model: RVD2000 with couple BRSN001
RVD30-10000 with couple BRSN003

Model	Inner hose diameter, mm	Outer hose diameter, mm	Min. radius of bend, mm	Length, mm	Max. operating pressure, Bar	Burst pressure (not less than), Bar	Weight per 1 meter of length, kg	Coupling fitting thread
RVD2000	6	16,6	105	2000	700	1600	0,7	K3/8"
RVDI2000	6	16,6	105	2000	700	2800	0,7	K3/8"
RVD30-10000	12	22	180	10000	300	1100	4,0	G1/2"

Designed for assembly of hydraulic systems, connection of hydraulic actuators and hydraulic equipment to each other, to remote locking and distribution elements, pumps. As a matter of convenience, it is recommended to use couplers BRSM001, BRSM003;

- Supplied length is 2m and more.
- Can be used in a cyclic dynamic load conditions.

Couplers



Couple BRSM001 with safety caps



Model: BRSD001

Model: BRSN001



Model: BRSN003

Model: BRSD003

These couplers are designed for quick connection of hydraulic equipment with each other, pumps.

— Snap coupling consists of two coupling halves fitted with one-way valves and protective caps that prevent contamination of internal cavities of joints when disconnected. Ball valves of both coupling halves allow to avoid the loss of hydraulic fluid when disconnected.

- Can be used in a cyclic dynamic load conditions.

Model	Coupling dimensions		Max. operating pressure, Bar	Weight, kg
	Female thread	Male thread		
BRSD001	—	K3/8"	800	0,3
BRSN001	K3/8"	—	800	0,2
BRSM001	K3/8"	K3/8"	800	0,5
BRSN003	—	G1/2"	350	0,25
BRSD003	G1/2"	—	350	0,10
BRSM003	G1/2"	G1/2"	350	0,40

BRSM=BRSD+BRSN

Fittings



SHU-1650
Elbow choke
Male thread:
K3/8"- K3/8"



SHMT-1651 Choke/
coupling T-coupling
Male thread: K3/8"
Female thread:
K3/8"-K3/8"



MK-1613
Cross coupling
Female thread:
K3/8"-K3/8"
K3/8"-K3/8"



MP-1614
Straight coupling
Female thread:
K3/8"- K3/8"



SHP-1617
Straight choke
Thread: K3/8"- K3/8"



SH-1601
Blank off plug
Thread: K3/8"



MT-1612
T-coupling
Female thread:
K3/8"- K3/8"- K3/8"



SHMU-1616
Elbow choke/coupling
Male thread: K3/8"
Female thread: K3/8"



SH-1602
Blank off plug
Thread: K1/4"



MU-1610
Elbow coupling
Female thread:
K3/8"- K3/8"

Valves and cranes



Model: RK80/5-1

Model: RPK80/5-1

Model: PK80/5-1

All hydraulic components of pumps are designed for a maximum pressure of 800 Bar and meet the single ENERPRED coupling standard, so they can easily be installed at any pump manufactured by ENERPRED.

Model	Max. operating pressure, Bar	Coupling thread
PK-80/5-1	800	K3/8"
RK-80/5-1	800	K3/8"
RPK-50/5-1	800	K3/8"

Valves

Output flow rate: 10 l/min
Pressure — 800 Bar



Model: GR-3IR-1

Model: GE-2GR-1

Model: GE-3DR-1

Designed for installed at pumps and connected control equipment and tools. They control the flow of hydraulic fluid, supplied by the pump into the hydraulic system. High-pressure hoses or coupler could be connected directly to the distributor.

Model	Description	Coupling thread
GR-3DR-1	Three-position manual valve locked neutral	K 3/8"
GR-3IR-1	Three-position manual with unloaded neutral	K 3/8"
GE-2GR-1	Two-position solenoid with unloaded neutral	K 3/8"
GE-3DR-1	Three-position solenoid with locked neutral	K 3/8"
GE-3IR-1	Three-position solenoid with unloaded neutral	K 3/8"

Air preparation equipment



Model: FM



Model: FRM

Air preparation equipment meant for installation at NPR pump with pneumatic engines.
 FILTER (F) is designed to collect dirt particles, condensation and moisture present in the supply line of compressed utility air.
 REGULATOR (R) is designed for reducing the pressure in the supply pneumatic system.
 AIR-OIL LUBRICATOR (M) provides the lubrication of pneumatic engine. It sprinkles the supply air with oil, as a result, increasing the service life of the engine.
 Versions:
 FM—Filter/air-oil lubricator
 FRM— Filter/regulator/air-oil lubricator

Air oil-coolers



Model: UH-1

Oil coolers are designed to cool the working fluid being drained into the tank. Generally, they are used in the process equipment working for a long time, or in pumps with tanks too small for natural cooling. Air cooled hydraulic oil cooler is basically a heat radiator with 24 V exhausting fan.

Model	Description	Output flow rate, l/min	Weight, kg
UH-1	Installing the cooler air	to 20-40	7
UH-2		to 60-70	16
UH-3		to 110-120	23
UH-4		to 140-150	30

Pump electric equipment

Electric connectors



Model: RSH-3

Model: RSH-1

Electrical accessories for pumps can be applied to any standard pump.

They are designed to connect pump control electric boxes to the main power supply.

Model	Power supply	Notes
RSH-1	220 V, 50 Hz	without cable
RSH-1K	220 V, 50 Hz	with cable of 2 m and more
RSH-3	380 V, 50 Hz	without cable
RSH-3K	380 V, 50 Hz	with cable of 2 m and more

Remote control panels



Model: PDU-1N

Model: PDU-3R

- Working voltage: 24 V
- Cables of any length are supplied on demand

Model	Description	Controlled devices	Range	Weight, kg
PDU-2R	Hand remote control panel	Electric engine + 2-pos. solenoid valve	4 m cable	0,5
PDU-3R	Hand remote control panel	Electric engine + 3-pos. solenoid valve	4 m cable	0,5
PDU-1N	Foot remote control panel	Electric engine or 2-pos. solenoid valve	4 m cable	1,1
PDU-1B	Wireless remote control panel	Electric engine or 2-pos. solenoid valve	50 m	0,1

Additional tanks



Model: BD63

Additional tanks are designed to increase the amount of hydraulic fluid in the system. They can be connected to the station with a connecting hose attached to the main tank and turned on and off by ball valve mounted on the tank.

Model	Volume, l	Dimensions (BxHxL), mm	Weight, kg
BD16	16	300x305x300	17,6
BD25	25	300x360x400	19,8
BD50	50	530x370x560	23,3
BD63	63	530x490x560	24,8
BD100	100	530x650x560	26,6
BD160	160	530x940x560	33,2

Additional mechanical accessories

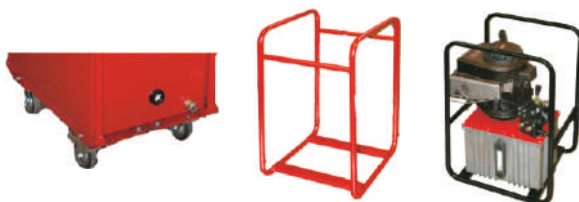

Wheels can be mounted to the following tanks: 10, 20, 40, 63 liters.
Wheel diameter: 75 mm.

Model: KNS-10 safety cage

Model NBR-1,218-1 in safety cage KNS-10

Pump tank can be equipped with a safety cage and wheels for easy movement.

Model	Volume, l	Weight, kg
KNS-10	10 and 20	4,5
KNS-40	40 and 63	6,5
KNS-100	100	7,5

High-pressure hoses

This unique technology is protected by patents 2151943, 2098710, 2132992.

Mechanical rubber components of these hoses are manufactured by Alfa Gomma and Manuli (both Italy), Hansa Flex (Germany), Semperit (Austria), Parker (USA).

Modern equipment produced by Finnish and Swedish manufactures provides the highest level of adhesion between the rubber parts and terminal fittings, and perfectly clean interior surface of the high-pressure hose.

18 Months Warranty!

And only for YOU:

The high quality of our products has been awarded with gold medals, diplomas and Grand Prizes at regional exhibitions and trade shows.

We can:

- Produce high-pressure hoses of any complexity and configuration, and deliver it to you by any acceptable means of transportation.
- Develop design documentation and high-pressure hoses technical operating conditions complying with national and international standards.
- Develop design documentation for high-end and very complex terminal fittings.
- Offer consultations on components of the hoses (rubber parts, terminal fittings): how the proper use of those components in operation of your equipment and tools will significantly increase the service life of high-pressure hoses.
- Supply some high-pressure hose prototypes for reliability tests conducted in most extreme climatic and technological conditions of your equipment and tools can endure. Establishing a business relationship with you, we take responsibility for your business as well.

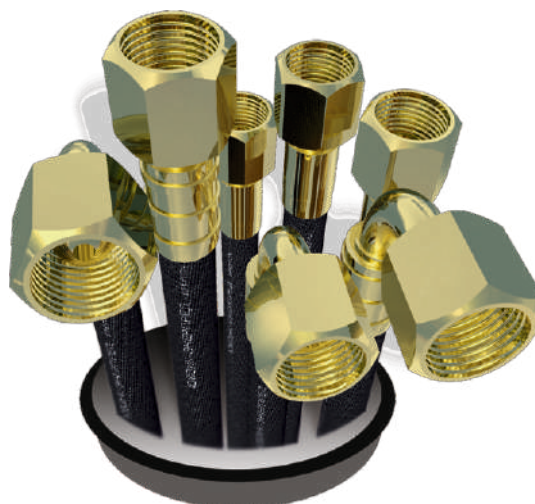

To order our high-pressure hoses you must fill in a form for each dimension-type of hoses and send it to us. If you are unable to fill the form, you can send us a request in arbitrary form with samples or sketches of desired terminal fittings.

To ensure that your orders are executed more quickly, please specify the grade or type of equipment used by your company.

High-pressure hoses for all types of tools and equipment of domestic and foreign manufacture

All hoses have a 2-fold safety margin for hydraulic shock during operation (operating pressure x 2 = water hammer pressure) and 4-fold burst margin. High-pressure hoses manufacturer ENERPRED guarantees quality and stable performance!

Hoses are manufactured under license of CJSC NPF «UVENK»

Application for production of high-pressure hoses

Dy: Nominal diameter, mm.

P: bursting pressure for hose, MPa.

10 atm = 10 bar. = 1 MPa

L: hose length, mm.

R: minimum hose bend radius, m

XX: fittings pattern code.

a1: bending angle of the left nipple, degrees

a2: bending angle of the right nipple, degrees.

a3: rotation angle of the right fitting with respect to the left fitting, degrees.

D: cap nut or threaded nipple thread size / flange or plain nipple diameter, mm.

K: climatic version (T, U1, HL)

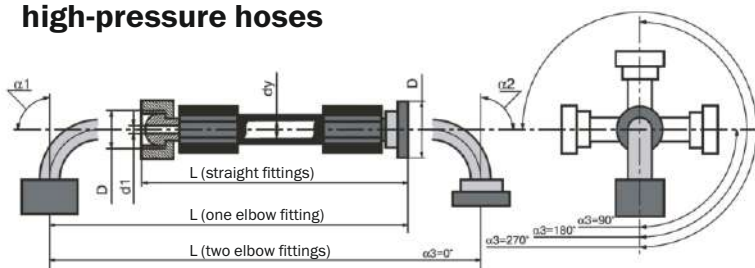

n/n	Dy	P burst	L	R	XX-a1	XX-a2	D	D	k	a3	Quantity	Grade or type of equipment; no. acc. to the catalogue

CODES OF TIPS EXECUTION ACCORDING TO TS3134-001-20871731-94, TS 3148-002-20871731-95, TS3148-004-20871731-96

<p>01</p> <p>Basic part with spherical sealing surface and coupling nut</p> <p>RVD</p> <p>NIPPLE WITH EXTERNAL CYLINDRICAL THREAD AND FEMALE CONE 37°</p>	<p>02</p> <p>Basic part with spherical sealing surface and coupling nut</p> <p>RVD</p> <p>NIPPLE WITH EXTERNAL CYLINDRICAL THREAD AND FEMALE CONE 24°</p>	<p>03</p> <p>Basic part with spherical sealing surface and coupling nut</p> <p>RVD</p> <p>NIPPLE WITH EXTERNAL CYLINDRICAL THREAD AND FEMALE CONE 60°</p>	<p>04</p> <p>Basic part with spherical sealing surface and coupling nut</p> <p>RVD</p> <p>NIPPLE WITH EXTERNAL CYLINDRICAL THREAD AND FEMALE CONE 74°</p>
<p>05</p> <p>Mating surface - plane</p> <p>RVD</p> <p>FLANGE NIPPLE WITH SEAL RING AND DISMOUNTABLE FASTENING PART</p>	<p>06</p> <p>Mating surface - cylinder</p> <p>RVD</p> <p>FLANGE NIPPLE WITH SEAL RING AND DISMOUNTABLE FASTENING PART</p>	<p>07</p> <p>Basic part Part for welding</p> <p>RVD</p> <p>FLAT NIPPLE FOR WELDED PIPELINES</p>	<p>08</p> <p>Basic part Rotary joint</p> <p>RVD</p> <p>NIPPLE WITH EYE LUG</p>
<p>09</p> <p>Basic part Rotary joint</p> <p>RVD</p> <p>NIPPLE WITH EYE LUG</p>	<p>10</p> <p>Basic part with external cylindrical thread and female cone 24°</p> <p>RVD</p> <p>FLAT NIPPLE FOR CUT RING</p>	<p>11</p> <p>Basic part with external cylindrical thread and female cone 37°</p> <p>RVD</p> <p>SPHERICAL NIPPLE WITH COUPLING NUT</p>	<p>12</p> <p>Basic part with external cylindrical thread and female cone 24°</p> <p>RVD</p> <p>SPHERICAL NIPPLE WITH COUPLING NUT</p>
<p>13</p> <p>Basic part with external cylindrical thread and female cone 60°</p> <p>RVD</p> <p>SPHERICAL NIPPLE WITH COUPLING NUT</p>	<p>14</p> <p>Basic part with external cylindrical thread and female cone 24°</p> <p>RVD</p> <p>FLAT NIPPLE WITH COUPLING NUT AND CUT RING</p>	<p>15</p> <p>Mating surface - plane</p> <p>RVD</p> <p>FLANGE NIPPLE WITH SEAL RING AND INTEGRAL FASTENING PART</p>	<p>16</p> <p>Basic part with male cone 37° and coupling nut</p> <p>RVD</p> <p>NIPPLE WITH EXTERNAL CYLINDRICAL THREAD AND FEMALE CONE 37°</p>
<p>17</p> <p>Basic part with male cone 24° and coupling nut</p> <p>RVD</p> <p>NIPPLE WITH EXTERNAL CYLINDRICAL THREAD AND FEMALE CONE 24°</p>	<p>18</p> <p>Basic part with male cone 60° and coupling nut</p> <p>RVD</p> <p>NIPPLE WITH EXTERNAL CYLINDRICAL THREAD AND FEMALE CONE 60°</p>	<p>19</p> <p>Basic part with male cone 74° and coupling nut</p> <p>RVD</p> <p>NIPPLE WITH EXTERNAL CYLINDRICAL THREAD AND FEMALE CONE 74°</p>	<p>20</p> <p>Basic part with male cone 90° and coupling nut</p> <p>RVD</p> <p>NIPPLE WITH FEMALE CONE 90° AND COUPLING NUT</p>
<p>21</p> <p>Basic part with external cylindrical thread and female cone 74°</p> <p>RVD</p> <p>NIPPLE WITH FEMALE CONE 74° AND COUPLING NUT</p>	<p>22</p> <p>Basic part with external cylindrical thread and male cone 60°</p> <p>RVD</p> <p>NIPPLE WITH FEMALE CONE 60° AND COUPLING NUT</p>	<p>23</p> <p>Basic part with internal cylindrical thread</p> <p>RVD</p> <p>THREADED NIPPLE WITH GASKET</p>	<p>24</p> <p>Basic part with internal tapered thread</p> <p>RVD</p> <p>NIPPLE WITH INTERNAL TAPERED THREAD</p>
<p>25</p> <p>Basic part with external tapered thread</p> <p>RVD</p> <p>NIPPLE WITH INTERNAL TAPERED THREAD</p>	<p>26</p> <p>Basic part with external cylindrical thread and male cone 60°, 74°</p> <p>RVD</p> <p>TOROIDAL NIPPLE WITH COUPLING NUT</p>	<p>27</p> <p>Basic part with external cylindrical thread and female cone 24°</p> <p>RVD</p> <p>NIPPLE WITH SPHERICAL COUPLING NUT</p>	<p>28</p> <p>Basic part with male cone 14° and coupling nut</p> <p>RVD</p> <p>NIPPLE WITH EXTERNAL CYLINDRICAL THREAD AND FEMALE CONE 14°</p>
<p>29</p> <p>Basic part with external cylindrical thread for gasket</p> <p>RVD</p> <p>TOROIDAL END NIPPLE 15° WITH COUPLING NUT</p>	<p>30</p> <p>Basic part with internal cylindrical thread for gasket</p> <p>RVD</p> <p>NIPPLE WITH CYLINDRICAL THREAD</p>	<p>31</p> <p>Basic part with female cone 37° and coupling nut</p> <p>RVD</p> <p>THREADED SPHERICAL NIPPLE WITH EXTERNAL CYLINDRICAL THREAD</p>	<p>32</p> <p>Basic part with female cone 24° and coupling nut</p> <p>RVD</p> <p>THREADED SPHERICAL NIPPLE WITH EXTERNAL CYLINDRICAL THREAD</p>

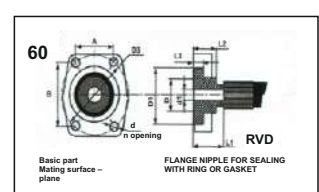
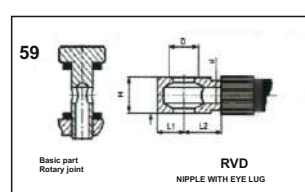
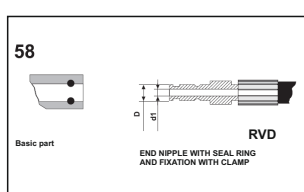
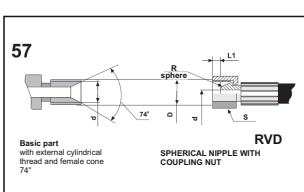
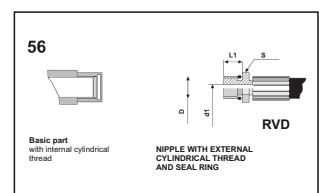
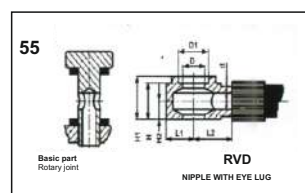
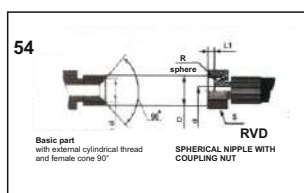
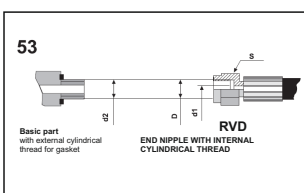
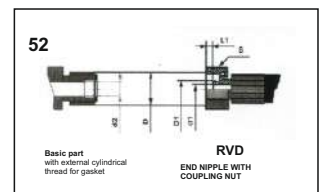
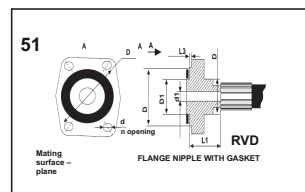
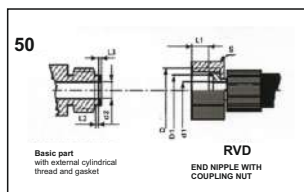
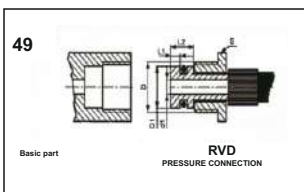
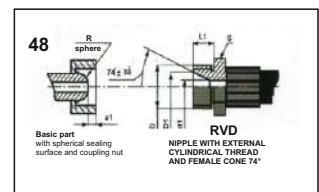
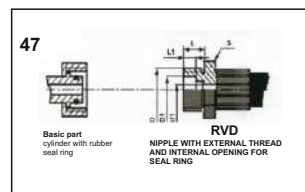
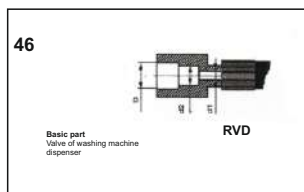
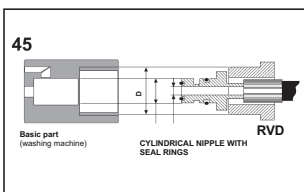
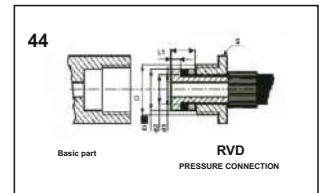
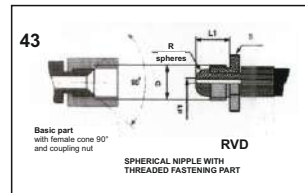
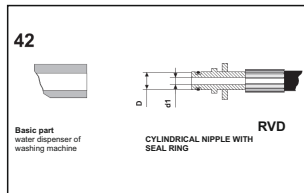
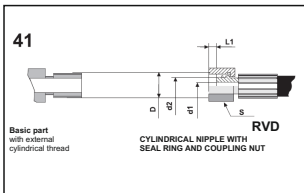
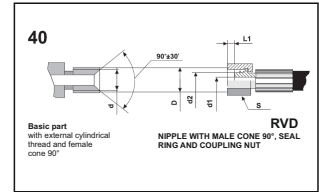
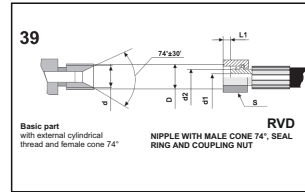
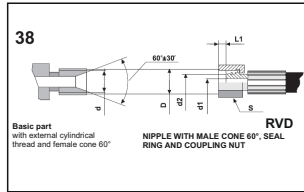
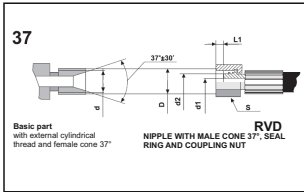
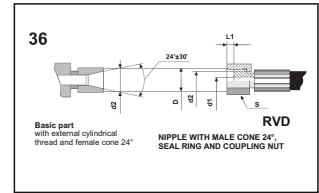
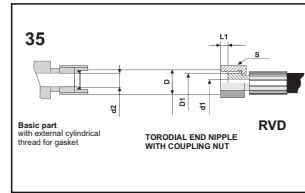
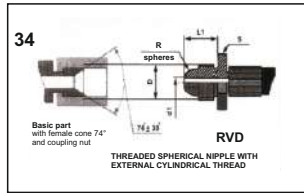
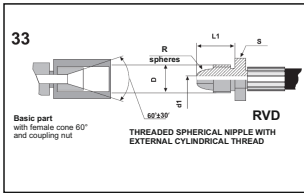

Single-acting load-lifting cylinders

Series DG...P...
Capacity – 10-100 ton
Pressure – 700 Bar
Spring stroke retraction

Designed for lifting and moving of cargo load during assembling, dismantling and repairing operations in various industries.

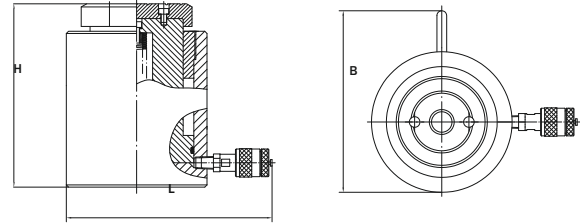

Load-lifting cylinders of TM Enerpred p.10

Models: DG20P100, DG20P150, DG50P100

Model	Capacity, ton	Stroke, mm	Oil working capacity, sm ³	Dimensions (BxLxH), mm	Weight, kg	Recommended pump
DG10P50	10	50	73	64x118x140	3,04	NRG-7010
DG10P100	10	100	145	64x118x192	4,04	NRG-7010
DG10P150	10	150	220	64x118x242	5,0	NRG-7010
DG20P50	20	50	140	135x145x160	6,48	NRG-7010
DG20P100	20	100	280	88x143x208	8,16	NRG-7010
DG20P150	20	150	420	88x143x258	10,06	NRG-7010
DG30P50	30	50	208	155x163x158	9,64	NRG-7010
DG30P100	30	100	416	108x163x208	12,78	NRG-7010
DG30P150	30	150	624	108x163x258	15,42	NRG-7020
DG50P50	50	50	350	178x183x163	13,86	NRG-7010
DG50P100	50	100	700	128x183x212	17,70	NRG-7020
DG50P150	50	150	1060	178x183x263	21,72	NRG-7020
DG100P50	100	50	660	225x230x163	26,18	NRG-7020

Self-contained cylinders

Series DA...M...
Capacity – 4-50 ton
Gravity stroke retraction

Have built-in pump with a removable handle, equipped with an additional screw to compensate for the distance between the support and the load, effectively avoiding the installation of additional pads.



Model: DA201M145V

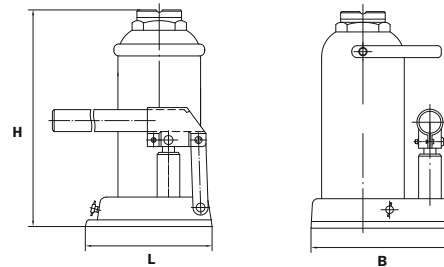

Model	Capacity, ton	Stroke, mm	Screw stroke, mm	Dimensions (BxLxH), mm	Weight, kg
DA41M110V	4	110	60	100x95x180	3,3
DA61M110V	6	110	60	108x108x180	4,5
DA81M125V	8	125	80	116x112x200	5,6
DA101M125V	10	125	80	123x116x200	6,3
DA121M125V	12	125	80	133x125x208	7,5
DA161M140V	16	140	80	140x133x226	9,0
DA201M145V	20	145	60	160x148x233	11,5
DA321M150	32	150	—	168x165x255	18,0
DA501M180	50	180	—	220x178x295	35,6

Hydraulic pullers with built-in pump

Series SGA...

Capacity — 3,3-20 ton

Spread range — 200-350 mm



Model: SGA320-1

The ultimate solution for removing machine parts fitted with preload, such as bearings, sprockets, gears and sheave wheels. Built-in pump with a removable handle is rotating through 360°, allowing to quickly and effectively dismantling the parts. Has a corrosion-resistant chrome finish and a safety valve.

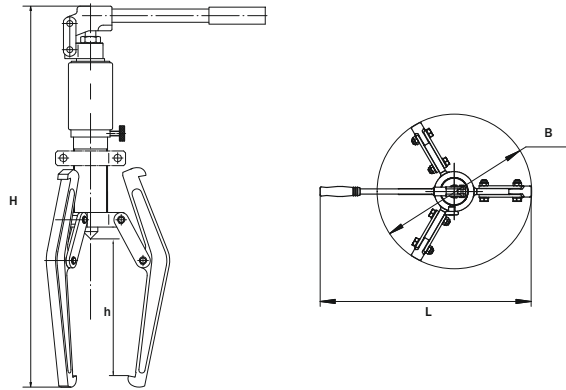

Pullers with built-in pump
TM Enerpred, p. 29

Model	Capacity, ton		Spread range, mm	Max. reach, mm	Stroke, mm	Dimensions (BxLxH), mm	Weight, kg
	3 jaws	2 jaws					
SGA305	5	3,3	200	140	55	60x125x510	6,5
SGA310-1	10	6,6	250	160	55	76x100x620	9
SGA320-1	20	13,4	350	200	68	90x140x770	14

Hydraulic frame-closed pipe benders

Series TG...R...

Capacity — 16-20 ton

Bending range — 1/2"-4"



Model: TG1R1650

Designed for cold bend of pipes according to GOST 3262-75. Rated pressure: 700 Bar.

- Benders are provided with a built-in hydraulic pump with manual transmission, enabling operation in absence of power supply;
- Equipped with a set of dies, providing a wide range of pipe bending dimensions;
- Lightweight and compact design allows for on-site installation of pipes;
- Capable to work in both the horizontal and vertical position.

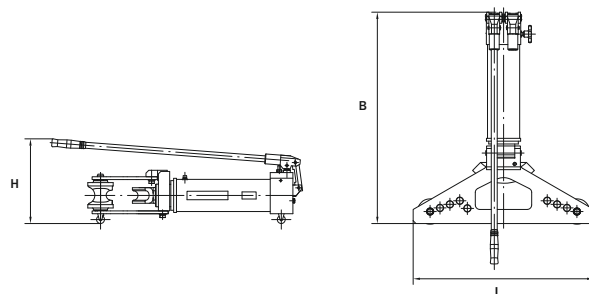

Pipe bender with closed frame
TM Enerpred p.24

Model	Bending range, inch	Bending capacity, ton	Thickness of pipe, mm	Dimensions (BxLxH), mm	Weight, kg
TG1R1650	1/2", 3/4", 1", 1 1/2", 2"	16	2,75-4,50	695x700x315	60
TG1R1880	1/2", 3/4", 1", 1 1/2", 2", 2 1/2", 3"	18	2,75-4,50	940x765x345	120
TG1R20100	1/2", 3/4", 1", 1 1/2", 2", 2 1/2", 3", 4"	20	2,75-6,00	1150x920x430	131

Hydraulic crimping presses

Series PP-NA...
Capacity – 16 ton
Crimping range – 10-300 mm²



Model: PP-NA16300

Designed for banding and jointing of wires and cables by means of crimping with suitable couplings and sleeves. Crimping is based on deformation of material of contacting pair "conductor + coupling/sleeve" leading to formation of contact zone in between.

Deformation form and degree are defined by set of dies and formers that come with the press.

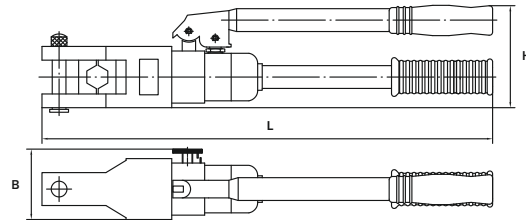

Model	Capacity, ton	Stroke, mm	Crimping range area, mm ²		Dimensions (BxLxH), mm	Weight, kg
			Aluminium	Copper		
PP-NA16300	16	22	10-240	10-300	75x485x145	4,2

Wire rope pulling hoist

Series MTM...
Capacity – 800-3200 kgf



Model: MTM-3,2/20

Designed for lifting and traction operation, as well as load descending, rope stretching and loosening. The operating principle of the tirfor winch mechanism is based on pulling the rope through the traction mechanism with two pairs of clamps that interchangeably compress the rope with a capacity proportional to the load weight, and pull it in the appropriate direction step by step.

- A 20-meter cable fitted with a hook;
- High strength aluminum alloy frame;
- Telescopic control lever with the ability of forward and reverse stroke;
- The opening on the top surface of the case eases the washing the inside of the tap. After washing and oiling the winch will be ready for operation again in no time.

Model	Capacity, kgf	Maximum handle capacity, kgf	Lever length, mm	Rope length, mm	Rope diameter, mm	Rated forward travel, mm	Dimensions (BxLxH), mm	Weight without wire, kg	Wire weight (20 m), kg
MTM-0,8/20	800	32	740	20	8,3	> 52	105x462x235	7,4	5,8
MTM-1,6/20	1600	42	1120	20	11	> 52	120x545x280	14,4	11,2
MTM-3,2/20	3200	44	1120	20	16	> 52	150x660x325	24,4	23,6

Hydraulic pallet truck

Series TGR...

Capacity— 1000-3500 kgf



Model: TGR1/800



Model: TGR2/190e



Model: TGR2/200



Model: TGR3,5/195

TGR1/800: with foot lift

TGR2/190e: with resin coating, abrasion and corrosion resistant

TGR2/200: with electronic scales

TGR3,5/195: steering angle of 210° degrees provides the maximum mobility

Model	Capacity, kgf	Lifting height, mm	Pickup height, mm	Fork length, mm	Steer wheel diameter, mm	Load wheel diameter, mm	Dimensions (BxLxH), mm	Weight, kg
TGR 1/800	1000	800	85	1150	180	74	520x1225x1515	110
TGR 2/190e	2000	190	75	1100	160	70	550x1470x1160	55
TGR 2/200	2000	200	85	1150	180	74	540x1515x1200	100
TGR 2,5/195	2500	195	85	1100	200	80	550x1477x1200	80
TGR 3,5/195	3500	195	85	1150	200	80	550x1550x1250	85

Scissor lift table

Series SPG...

Capacity — 300-800 kgf

Lifting height — up to 1000 mm



Model: SPG0,3/900

Hydraulic tables are essentially durable, reliable and low-wearing equipment for lifting and transportation of a variety of goods. Presence of foot hydraulic lift control and manual lowering system makes the work easy and convenient.

Model	Capacity, kgf	Lifting height, mm	Minimum table height, mm	Table dimensions, mm	Dimensions (BxLxH), mm	Weight, kg
SPG 0,3/900	300	900	280	815x500x50	500x935x1000	75
SPG 0,5/900	500	900	280	815x500x50	500x935x1000	85
SPG 0,8/1000	800	1000	420	1000x515x55	515x996x1150	115
SPG 1,5/1000	1500	1000	420	1000x515x55	515x1170x1000	135

Hydraulic crane

Series KGS...
Capacity – 400-2000 kgf
Lifting height – 50-2382 mm



Model: KGS1000

Designed for cargo lifting and handling; crane relocation is carried out manually, lifting is performed by hydraulic actuation. Cranes are equipped with a hydraulic cylinder with manually actuated integrated pump. Telescopic crane arm can be fixed in several positions.

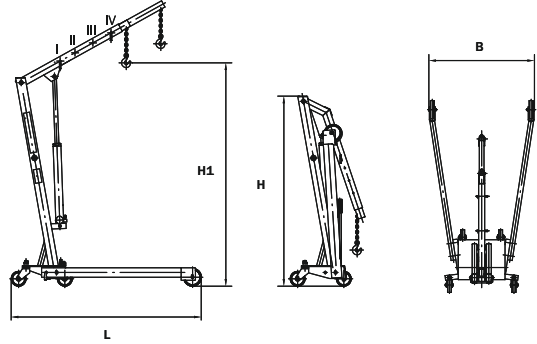

Model	Rated capacity, kgf				Lifting height H, mm	Dimensions (BxLxH), mm		Weight, kg
	I	II	III	IV		Operating mode	Folded down	
KGS1000	1000	800	800	400	50-1800	920x1061x1210	700x500x1210	72
KGS2000	2000	1500	1000	500	50-2382	920x1061x1475	700x500x1475	75

Hydraulic stackers

Series SHGR..., SHGEE...
Capacity – 500-2000 kgf
Lifting height – 1500-3000 mm

Designed for lifting, moving and lowering of cargo loads for the purpose of storage and retrieval operations. Solid steel frame, protective screen allows protecting the operator without view obstruction.
 SHGR series: user-friendly manual operations and maneuverability, adjustable lowering speed, decent compact size (could pass the standard doors).
 SHGEE series: self-propelled hydraulic stackers with an electric lift drive.



Model: SHGR1/2500



Model: SHGEE1/3000



Model: SHGEE2/3000

Model	Capacity, kgf	Lifting height, mm	Dimensions (BxLxH), mm	Weight, kg
SHGR0,5	500	1500	810x1340x2000	149
SHGR1	1000	1500	740x1640x2050	230
SHGR1/2500	1000	2500	860x1640x2050	276

Model	Capacity, kgf	Lifting height, mm	Engine power, kW		Dimensions (BxLxH), mm	Weight, kg
			Moving	Lifting		
SHGEE1/3000	1000	3000	0,65	2,2	1748x800x2090	550
SHGEE2/3000	2000	3000	1,5	3	850x2100x1985	1550

Lifters

Series PT..., PP...

Capacity — 125-500 kgf

Lifting height — 6-16 mm



Models: PT...

Lifts are designed for installation, maintenance and building operations in industrial plants, malls and exhibition centers, gym halls, airports, building facades, etc.

PT series: scissor-type lifts.

PP series: telescopic lifts. Light weight of telescopic mast is ensured by construction of special aluminum alloy. Lift controls are located on a central console mounted on the lift chassis, and on the operator panel on the lifting platform.

— To maintain a stable tilt base, lifts are equipped with hinged supports, designed to align the lift and prevent tilting.

— Mobile telescopic lifts feature compact design, ease of use and maintenance, and, above all, high reliability.



Models: PP...

Model	Capacity, kgf	Lifting height, mm	Platform size, mm	Power supply voltage, V	Dimensions , (BxLxH), mm	Engine power, kW	Weight, kg
PT0,125/8	125	8	600x500	220	800x1300x2100	0,7	300
PT0,3/8	200	8	1180x600	220	850X1350X2000	1,1	480
PT0,3/10	200	10	1380x600	220	950X1150X2000	1,1	610
PP0,3/6	300	6	1800x880	380	1200x2100x1200	1,1	850
PP0,3/12	300	12	2450x1350	380	1600x2700x2000	2,2	2350
PP0,3/14	300	14	2450x1350	380	1600x2700x2200	2,2	2700
PP0,3/16	300	16	2750x1500	380	1750x3000x2200	3	3100
PP0,5/6	500	6	1800x880	380	1200x2100x1200	1,1	850

- **Battery Powered Tools** feature compact Li-Ion batteries. Their advantages: high energy density, low self-discharge, no memory effect;
- Operating head is rotatable through 360 ° to provide access to the most sophisticated work areas;
- The hydraulic unit is equipped with a two-stage pump, which provides a fast approach stroke idling;
- Ergonomic grip allows for crimping, cutting and punching with one hand;
- Equipped with a LED to indicate the insufficient battery level;
- Equipped with a manual stroke return button for malfunction cases;
- Controls with a start button;
- Temperature sensor causes automatic shutdown when tool temperature exceeds 60°;
- At the nominal pressure, the hydraulic unit provides automatic stroke return to the starting position;
- All models are supplied in steel cases.

Crimping presses

Series PNE...

Capacity — 5-12 tf

Crimping range — 16-400 mm²



Models: PNE240, PNE300, PNE400

Designed for crimping of tips, sleeves, and various stretching, connecting, T-coupling, and terminal clamps for installation of wires and cables of power lines and open switchgears. Models are autonomous and have built-in electro-hydraulic actuator.

The package includes:

- Set of crimping dies
- 2x Battery
- Battery charging device



Model: PNE400 in the case

Model	Capacity, ton	Profile	Crimping range, mm ²	Stroke, mm	Power supply, V	Crimping time, s	Dimensions, (BxLxH), mm	Charging time, h
PNE240	5	⬡	16-240	12	18	3-6	—	2
PNE300	6		16-300	17	18	3-6	—	2
PNE400	12		16-400	42	18	6-18	75x415x330	2

Cable cutters

Series NKE...

Capacity — 6 ton

Overcut cable diameter — 45-85 mm



Model: NKE45, NKE85

Electrohydraulic-driven cutters designed to cut cables and wires with aluminum and copper conductors, including armored and stranded wires of the same material, except cables and wires with a steel core.

The package includes:

- Blades
- 2x Battery
- Battery charging device.



Model: NKE85 in the case

Model	Capacity, ton	Overcut cable diameter, mm	Stroke, mm	Power supply, V	Dimensions, (BxLxH), mm	Charging time, h
NKE45	6	45	50	18	75x505x385	2
NKE85	6	85	86	18	75x505x385	2

Multi-functional tool

Series NPPE...

Capacity — 6 ton

Crimping range — 16-300 mm²

Overcut cable diameter — 45-85 mm

Punching diameter — 22.5-61.5 mm



Model: NPPE06







Versatile multipurpose tool with interchangeable adapters for crimping, cable cutting, or punching holes in metal sheets (thickness up to 3.5 mm).

The package includes:

- Set of crimping dies
- Set of punching dies
- Blades
- Adapter for crimping
- Adapter for punching
- 2x Battery
- Battery charging device.



Model: NPPE06 in the case

	Copper cable crimping (section area): 16-300 mm ² Aluminium cable crimping 0-240 mm ²	
	Cu/Al cable cutting, diameter: 40 mm	
	Metal sheets hole punching (thickness 3.5 mm) 22.5-61.5 mm	

Model	Capacity, ton	Overcut cable diameter, mm	Crimping range, mm ²	Puncing diameter, mm	Stroke, mm	Power supply, V	Dimensions (BxLxH), mm	Charging time, h
NPPE06	6	40	16-300	22.5-61.5	42	18	75x390x335	2

Pump stations with electric drive

Series NER...A...

Pressure — 700 Bar



Model: NER2/70-5/0,7A8F2

Pump stations with electric drive of NER series are designed for hydraulic oil pumping into various mechanisms operating from hydraulic drive in temperate conditions.

They possess the following advantages: low price, small size, intuitive mechanism and control.

Pump stations with electric drive
TM Enerpred page 83

Model	Tank volume, L	Motor power, kW	Power supply, V	Pressure, Bar		Capacity, L/min		Overall dimensions (BxLxH), mm	Weight, kg
				1 stage	2 stage	1 stage	2 stage		
NER2/70-5/0,7A8F2	8	0,75	220	20	700	5	0,7	322x240x380	22
NER2/70-10/3A40T2	40	3,0	380	20	700	10	3,0	480x360x700	56

ADVANTAGES AND DIFFERENCES TD ENERPRED EQUIPMENT

Strict quality control system

Our enterprise has carried out continuous monitoring at all stages of production, beginning with checking the quality of materials and finishing checking the quality of the finished product.

Increased strength, compactness and light weight of the tool

Due to the use of a tool manufacturing of heat-treated steels, strength of the products is increased in comparison with the products made of non-heat-treated steel. It allows our instrument to withstand heavy loads at relatively low weight and compact design.

Making essential parts by stamping

In the manufacture of essential parts used method of stamping tool. It gives a good structure of the material, strength, reduces the need for metal, and provides maximum approximate form of harvested parts.

Effective protective coating

Protective coating TD Enerpred is different by type and selected depending on the product: chemical, oxidized (black) - the most affordable, zinc, hard chrome plating, powder coating polymer paint with increased resistance. Method of powder coating - abrasion-resistant coating that protects from corrosion metal, and the aesthetic appearance.

Selecting protective coating technology takes into account the nature of a essential tool problems and conditions of use. It guarantees an optimum value of the instrument, its operating properties and provides long service life while maintaining aesthetic condition of product.

High class interior of surface roughness

In manufacturing the inner surface of the cylinder TD Enerpred made a number of finishing operations for high-class roughness. This allows the compaction of the long run.

Cylinder design

Besides the standard seal elements based on rubber rings in the TD Enerpred products used for sealing elements of the leading Russian and foreign manufacturers. For operating at high temperatures, heat-resisting rubber gaskets are installed on the products.

Sealing elements

In addition to standard sealing elements on the basis of rubber rings in the products of TM Enerpred used for sealing elements of the leading Russian and foreign manufacturers. To operate at high temperatures seals from heat resistant rubber are installed on the products.

Several versions of the tool

A significant number of models TD Enerpred tool has several options: with manual operating, with built-in hydro-electric, with an external hydro, electricity, gasoline and air motor. Such diversity allows choosing the best option for you only.

Tool mark

Since 2006, all instrument of TM Enerpred is applied with mechanical shock marking. It guarantees the authenticity of the purchased your instrument. Such measure is a way to protect against forgery, the number of which, unfortunately, constantly growing.

Mechanical shock marking is a sequence of points produced by vibrations of carbidic tungsten needle.

Mechanical shock marking TM Enerpred contains a logo, model and serial number of the product.



Post address: 664040, Irkutsk, Roza Luxemburg, str.,184,p/b 129
tel.: +7(3952) 211-140, fax: +7(3952) 211-139
www.enerpred.com
e-mail: info@enerpred.com, zakaz@enerpred.com